



Syllabus

Diploma in Mechanical Engineering (Machine Tool Maintenance and Repairs) (Sandwich)

www.binils.com

Course Code: 2022

2015 -16

M – SCHEME

DIRECTORATE OF TECHNICAL EDUCATION

GOVERNMENT OF TAMILNADU

STATE BOARD OF TECHNICAL EDUCATION & TRAINING, TAMILNADU
DIPLOMA IN ENGINEERING / TECHNOLOGY SYLLABUS
M SCHEME

(Implemented from the Academic year 2015 - 2016 onwards)

Chairperson

Tmt. S.MADHUMATHI, I.A.S.,
Director
Directorate of Technical Education
Guindy, Chennai.

Dr. K.SUNDARAMOORTHY, M.E., Phd.,
Additional Director of Technical Education (Polytechnics)
Directorate of Technical Education
Guindy, Chennai.

Co-ordinator

Dr. M.Isakkimuthu, Phd.,
Principal
Bharathiar Centenary Memorial Girls Government College
Ettayapuram-628902

Members

Convener

Dr. R.R.Rajkumar B.Sc, M.E, PhD
Head of the Department (MTMR)
AMK Technological Polytechnic College
Sembarambakam, Chennai -600 123

Members:

Mr. S.N.Sundar, M.E Lecturer (Selection Grade) AMK Technological Polytechnic College Sembarambakam, Chennai -600 123	Dr.C.Thiagarajan, M.E, PhD Professor, Department of Mechanical Engineering, Savitha School of Engineering, Savitha University
Mr.S. Murali, M.E Lecturer (Senior Grade) AMK Technological Polytechnic College Sembarambakam, Chennai -600 123	Mr.V.Kumar, Manager (Maintenance) M/S BRAKES INDIA Ltd, Padi, Chennai – 600 050
Mr.N.Ramu, M.E Lecturer (Senior Grade) AMK Technological Polytechnic College Sembarambakam, Chennai -600 123	Mr.N.Dhakshnamoorthy, Manager (Maintenance) M/S TAFE (Tractors and Form Equipment Ltd) Chennai
Mr. K.HemaPrasad, Head of the Department (Mechatronics) T.S.Srinivasan Centre for Polytechnic College and Advanced Training (CPAT – TVS)	

DIPLOMA COURSES IN ENGINEERING/TECHNOLOGY

(SEMESTER SYSTEM)

(Implemented from 2015- 2016)

M – SCHEME

REGULATIONS*

* *Applicable to the Diploma Courses other than Diploma in Hotel Management & Catering Technology and the Diploma Courses offered through MGR Film Institute, Chennai.*

1. Description of the Course:

a. Full Time (3 years)

The Course for the full Time Diploma in Engineering shall extend over a period of three academic years, consisting of 6 semesters* and the First Year is common to all Engineering Branches.

b. Sandwich (3½ years)

The Course for the Diploma in Engineering (sandwich) shall extend over a period of three and half academic years, consisting of 7 semesters* and the First Year is common to all Engineering Branches. The subjects of three years full time diploma course being regrouped for academic convenience.

During 4th and/or during 7th semester the students undergo industrial training for six months/ one year. Industrial training examination will be conducted after completion of every 6 months of industrial training

c. Part Time (4 years)

The course for the diploma in Engineering shall extend over a period of 4 academic years containing of 8 semesters*, the subjects of 3 year full time diploma courses being regrouped for academic convenience.

* Each Semester will have 15 weeks duration of study with 35 hrs. /Week for Regular Diploma Programme and 18hrs/ week (21 hrs. / Week I year) for Part-Time Diploma Programmes.

The Curriculum for all the 6 Semesters of Diploma courses (Engineering & Special Diploma Courses viz. Textile Technology, Leather Technology, Printing Technology, Chemical Technology etc.) have been revised and revised curriculum is applicable for the candidates admitted from 2015 – 2016 academic year onwards.

2. Condition for Admission:

Condition for admission to the diploma courses shall be required to have passed in

The S.S.L.C Examination of the Board of Secondary Education, TamilNadu.

(Or)

The Anglo Indian High School Examination with eligibility for Higher Secondary Course in TamilNadu.

(Or)

The Matriculation Examination of Tamil Nadu.

(Or)

Any other Examination recognized as equivalent to the above by the Board of Secondary Education, TamilNadu.

Note: In addition, at the time of admission the candidate will have to satisfy certain minimum requirements, which may be prescribed from time to time.

3. Admission to Second year (Lateral Entry):

A pass in HSC (Academic) or (Vocational) courses mentioned in the Higher Secondary Schools in TamilNadu affiliated to the TamilNadu Higher Secondary Board with eligibility for university Courses of study or equivalent examination, & Should have studied the following subjects.

Sl. No	Courses	H.Sc Academic	H.Sc Vocational	
		Subjects Studied	Subjects Studied	
			Related subjects	Vocational subjects
1.	All the Regular and Sandwich Diploma Courses	Maths, Physics & Chemistry	Maths / Physics / Chemistry	Related Vocational Subjects Theory & Practical
2.	Diploma course in Modern Office Practice	English & Accountancy English & Elements of Economics English & Elements of Commerce	English & Accountancy, English & Elements of Economics, English & Management Principles & Techniques, English & Typewriting	Accountancy & Auditing, Banking, Business Management, Co-operative Management, International Trade, Marketing & Salesmanship, Insurance & Material Management, Office Secretaryship.

- For the diploma Courses related with Engineering/Technology, the related / equivalent subjects prescribed along with Practical may also be taken for arriving the eligibility.
- Branch will be allotted according to merit through counseling by the respective Principal as per communal reservation.
- For admission to the Textile Technology, Leather Technology, Printing Technology, Chemical Technology and Modern Office Practice Diploma courses the candidates studied the related subjects will be given first preference.
- *Candidates who have studied Commerce Subjects are not eligible for Engineering Diploma Courses.*

4. Age Limit: No Age limit.

5. Medium of Instruction: English

6. Eligibility for the Award of Diploma:

No candidate shall be eligible for the Diploma unless he/she has undergone the prescribed course of study for a period of not less than 3 academic years in any institution affiliated to the State Board of Technical Education and Training, TamilNadu, when joined in First Year and two years if joined under Lateral Entry scheme in the second year and passed the prescribed examination.

The minimum and maximum period for completion of Diploma Courses are as given below:

Diploma Course	Minimum Period	Maximum Period
Full Time	3 Years	6 Years
Full Time(Lateral Entry)	2 Years	5 Years
Sandwich	3½ Years	6½ Years
Part Time	4 Years	7 Years

7. Subjects of Study and Curriculum outline:

The subjects of study shall be in accordance with the syllabus prescribed from time to time, both in theory and practical. The curriculum outline is given in Annexure - I

8. Examinations:

Board Examinations in all subjects of all the semesters under the scheme of examinations will be conducted at the end of each semester.

The Internal assessment marks for all the subjects will be awarded on the basis of continuous internal assessment earned during the semester concerned. For each subject 25 marks are allotted for internal assessment and 75 marks are allotted for Board Examination.

9. Continuous Internal Assessment:

A . For Theory Subjects:

The Internal Assessment marks for a total of 25 marks, which are to be distributed as follows:

i. Subject Attendance

5 Marks

(Award of marks for subject attendance to each subject theory/practical will as per the range given below)

80% - 83%	}	1 Mark
84% - 87%		2 Marks
88% - 91%		3 Marks
92% - 95%		4 Marks
96% - 100%		5 Marks

ii) Test

10 Marks

2 Tests each of 2 hours duration for a total of 50 marks are to be conducted. Out of which the best one will be taken and the marks to be reduced to: 05 marks

The Test – III is to be the Model test covering all the five units and the marks so obtained will be reduced to : 05 marks

Total 10 marks

TEST	UNITS	WHEN TO CONDUCT	MARKS	DURATION
Test I	Unit – I & II	End of 6 th week	50	2 Hrs
Test II	Unit – III & IV	End of 12 th week	50	2 Hrs
Test III	Model Examination - Compulsory Covering all the 5 Units. (Board Examination-question paper-pattern).	End of 15 th week	75	3 Hrs

- From the Academic year 2015-2016 onwards.

Question Paper Pattern for the Periodical Test :(Test - I & Test- II)

With no choice:

PART A type questions:	4 Questions X 2 mark	8 marks
PART B type questions:	4 Questions X 3 marks	12 marks
PART C type questions:	3 Questions X 10 marks	30 marks

	Total		50 marks

iii) Assignment

10 Marks

For each subject Three Assignments are to be given each for 20 marks and the average marks scored should be reduced for 10 marks

All Test Papers and assignment notebooks after getting the signature with date from the students must be kept in the safe custody in the Department for verification and audit. It should be preserved for 2 Semesters and produced to the flying squad and the inspection team at the time of inspection/verification.

B. For Practical Subjects:

The internal assessment mark for a total of 25 marks which are to be distributed as follows:-

a)	Attendance	:	5 Marks
	(Award of marks as same as Theory subjects)		
b)	Procedure/ observation and tabulation/ Other Practical related Work	:	10 Marks
c)	Record writing	:	10 Marks

	TOTAL	:	25 Marks

- *All the Experiments/exercises indicated in the syllabus should be completed and the same to be given for final board examinations.*
- The Record for every completed exercise should be submitted in the subsequent Practical classes and marks should be awarded for 20 for each exercise as per the above allocation.
- At the end of the Semester, the average marks of all the exercises should be calculated for 20 marks and the marks awarded for attendance is to be added to arrive at the internal assessment mark for Practical. (20+5=25 marks)
- The students have to submit the duly signed bonafide record note book/file during the Practical Board Examinations.

- All the marks awarded for assignment, Test and attendance should be entered in the Personal Log Book of the staff, who is handling the subject. This is applicable to both Theory and Practical subjects.

10. Life and Employability Skill Practical:

The Life and Employability Skill Practical with more emphasis is being introduced in IV Semester for Circuit Branches and in V Semester for other branches of Engineering.

Much Stress is given to increase the employability of the students:

Internal assessment Mark **25 Marks**

11. Project Work:

The students of all the Diploma Programmes (**except Diploma in Modern Office Practice**) have to do a Project Work as part of the Curriculum and in partial fulfillment for the award of Diploma by the State Board of Technical Education and Training, Tamilnadu. In order to encourage students to do worthwhile and innovative projects, every year prizes are awarded for the best three projects i.e. institution wise, region wise and state wise. **The Project work must be reviewed twice in the same semester.**

a) Internal assessment mark for Project Work & Viva Voce:

Project Review I	...	10 marks
Project Review II	...	10 marks
Attendance	...	05 marks (award of marks same as theory subjects pattern)

Total	...	25 marks

Proper record to be maintained for the two Project Reviews, and It should be preserved for 2 Semesters and produced to the flying squad and the inspection team at the time of inspection/verification.

b) Allocation of Mark for Project Work & Viva Voce in Board Examination:

Viva Voce	...	30 marks
Marks for Report Preparation, Demo	...	35 marks

	Total	65 marks

c) Written Test Mark (from 2 topics for 30 minutes duration): \$

i) Environment Management	2 questions X 2 ½ marks	= 5 marks
ii) Disaster Management	2 questions X 2 ½ marks	= 5 marks

		10marks

\$ - Selection of Questions should be from Question Bank, by the External Examiner.

No choice need be given to the candidates.

Project Work & Viva Voce in Board Examination	--	65 Marks
Written Test Mark (from 2 topics for 30 minutes duration)	--	10 Marks
TOTAL	--	75 Marks

A neatly prepared PROJECT REPORT as per the format has to be submitted by individual during the Project Work & Viva Voce Board examination.

12. Scheme of Examinations:

The Scheme of examinations for subjects is given in **Annexure - II**.

13. Criteria for Pass:

1. No candidate shall be eligible for the award of Diploma unless he/she has undergone the prescribed course of study successfully in an institution approved by AICTE and affiliated to the State Board of Technical Education & Training, Tamil Nadu and pass all the subjects prescribed in the curriculum.
2. A candidate shall be declared to have passed the examination in a subject if he/she secures not less than *40% in theory subjects* and *50% in practical subject* out of the total prescribed maximum marks including both the internal assessment and the Board Examination marks put together, subject to the condition that he/she secures at least a minimum of *30 marks out of 75 marks in the Board's Theory examinations and a minimum of 35 marks out of 75 marks in the Board Practical Examinations.*

14. Classification of successful candidates:

Classification of candidates who will pass out the final examinations from April 2018 onwards (Joined in first year in 2015-2016) will be done as specified below.

First Class with Superlative Distinction:

A candidate will be declared to have passed in **First Class with Superlative Distinction** if he/she secures not less than 75% of the marks in all the subjects and passes all the semesters in the first appearance itself and passes all subjects within the stipulated period of study 3/ 3½/ 4 years (Full Time/Sandwich/Part Time) without any break in study.

First Class with Distinction:

A candidate will be declared to have passed in **First Class with Distinction** if he/she secures not less than 75% of the aggregate of marks in all the

semesters put together and passes all the semesters except the I and II semesters in the first appearance itself and passes all the subjects within the stipulated period of study 3/ 3½/ 4 years (Full Time/Sandwich/Part Time) without any break in study.

First Class:

A candidate will be declared to have passed in **First Class** if he/she secures not less than 60% of the aggregate marks in all semesters put together and passes all the subjects within the stipulated period of study 3/ 3½ / 4 years (Full Time/Sandwich/Part Time) without any break in study.

Second Class:

All other successful candidates will be declared to have passed in **Second Class**.

The above mentioned classifications are also applicable for the Sandwich / Part-Time students who pass out Final Examination from October 2018 /April 2019 onwards (both joined in First Year in 2015-2016)

15. Duration of a period in the Class Time Table:

The duration of each period of instruction is 1 hour and the total period of instruction hours excluding interval and Lunch break in a day should be uniformly maintained as 7 hours corresponding to 7 periods of instruction (Theory & Practical).

16. Seminar:

For seminar the total seminar 15 hours(15 weeks x 1hour) should be distributed equally to total theory subject per semester(i.e 15 hours divided by 3/4 subject). A topic from subject or current scenario is given to students. During the seminar hour students have to present the paper and submit seminar material to the respective staff member, who is handling the subject. It should be preserved for 2 Semesters and produced to the flying squad and the inspection team at the time of inspection/verification.

-xXx-

**Diploma in Mechanical Engineering (MTMR) (SW) - M-Scheme
List of Equivalent Subjects for L - Scheme to M - Scheme
III SEMESTER – WITH EFFECT FROM OCTOBER 2016**

SI No	Subject Code	L-SCHEME	Subject Code	M-SCHEME
01	22031	Strength of Materials	39231	Solid Mechanics and Fluid Power
02	29232	Industrial Hydraulics And Pneumatics	39231	Solid Mechanics and Fluid Power
03	22033	Renewable Energy Sources**	39252	Thermal and Renewable Energy
04	22034	Machine Drawing**	32033	Machine Drawing**
05	22035	Mechanical Testing & Quality Control Practical **	32045	Strength of Materials and Fluid Mechanics Practical
06	22036	Fluid Power Practical **	32045	Strength of Materials and Fluid Mechanics Practical
07	20001	Computer Applications Practical	32034	Computer Applications and CAD Practical

www.binils.com

IV SEMESTER WITH EFFECT FROM APRIL 2017

SI No	Subject Code	L-SCHEME	Subject Code	M-SCHEME
01	22041	Manufacturing Technology –I**	39232	Industrial Production Technology – I
02	22045	Manufacturing Technology - I Practical**	32036	Lathe and Drilling Practical
03	29291	Industrial Training – I (Report Writing & Viva Voce)	39291	Industrial Training – I (Report Writing & Viva Voce)

V SEMESTER – WITH EFFECT FROM OCTOBER 2017

Sl No	Subject Code	L-SCHEME	Subject Code	M-SCHEME
01	29251	Thermal Equipments And Energy Conservation	39252	Thermal and Renewable Energy
02	22043	Electrical Drives & Control**	32044	Electrical Drives & Control**
03	29253	Metrology and Instrumentation	39253	Engineering Metrology
04	29254	Industrial Equipment Maintenance	39254	Maintenance of Machine Drive Elements
05	22044	Computer Aided Machine Drawing Practical **	32034	Computer Applications and CAD Practical
06	29256	Thermal Equipments Performance Practical	39258	Thermal Equipments Performance Practical
07	29257	Metrology and Instrumentation Practical	32037	Metrology and Metallography Practical *
08	22047	Electrical Drives and control practical**	32047	Electrical Drives & Control Practical

VI SEMESTER – WITH EFFECT FROM APRIL 2018

Sl No	Subject Code	L-SCHEME	Subject Code	M-SCHEME
01	22052	Manufacturing Technology - II**	39251	Industrial Production Technology - II
02	29262	Machine Tool Reconditioning & Overhauling	39264	Machine Tool Reconditioning and Overhauling
03	22061	Industrial Engineering and Management**	39265	Engineering Management
04	22062	Computer Integrated Manufacturing **	32062	Computer Aided Design and Manufacturing
05	29265	Total Productive Maintenance	39263	Total Quality Management and Total Productive Maintenance
06	22056	Manufacturing Technology – II Practical**	32046	Special Machines Practical
07	22064	Computer Integrated Manufacturing Practical **	32064	Computer Aided Design and Manufacturing Practical
08	20002	Communication & Life Skills Practical *	30002	Life and Employability skill Practical**

VII SEMESTER

Sl No	Subject Code	L-SCHEME	Subject Code	M-SCHEME
01	29271	Machine Tool Reconditioning &Overhauling Practical	39271	Maintenance Lab - II
02	22065	Process Automation Practical**	32055	Process Automation Practical
03	29273	Project Work	39273	Project Work
04	29292	Industrial Training – II (Report Writing & Viva Voce)	39292	Industrial Training – II (Report Writing & Viva Voce)

www.binils.com

M SCHEME

Implemented from 2015 - 2016

CURRICULUM OUTLINE

2022: DIPLOMA IN MECHANICAL ENGINEERING (Machine Tool Maintenance and Repairs (sandwich))

III SEMESTER

Subject code	Subject	Hours per week			
		Theory	Tutorial /Drawing	Practical	Total
39231	Solid Mechanics and Fluid Power	6	-	-	6
39232	Industrial Production Technology – I	5	-	-	5
39233	Lubrication Technology	5	-	-	4
32033	Machine Drawing*	-	4	-	6
32034	Computer Application & CAD Practical*	-	-	6	4
32036	Lathe and Drilling Practice*	-	-	4	4
32045	Strength of Material and Fluid Mechanics Practical*	-	-	4	4
Seminar		1	-	-	1
Total		17	4	14	35

IV SEMESTER

S.No	Subject	Hours per week			
		Theory	Tutorial /Drawing	Practical	Total
32037	Metrology and Metallography Practical *			4	4
32035	Foundry and Welding Practical*			3	3
39291	Industrial Training – I (Report Writing & Viva Voce)				NA

V SEMESTER

SI No	Subject	Hours per week			
		Theory	Tutorial /Drawing	Practical	Total
39251	Industrial Production Technology - II	4	-	-	4
39252	Thermal and Renewable Energy	4	-	-	4
39253	Engineering Metrology	4	-	-	4
39254	Maintenance of Machine Drive Elements	4	-	-	4
32044	Electrical Drives and Control*	6	-	-	6
32046	Special Machine Practical*	-	-	4	4
32047	Electrical Drives and Control Practical*	-	-	4	4
39258	Thermal Equipment Performance Practical	-	-	4	4
Seminar		1	-	-	1
Total		23	-	12	35

VI SEMESTER

S.No	Subject	Hours per week			
		Theory	Tutorial /Drawing	Practical	Total
39261	Industrial Automation	5	-	-	5
39262	Auxiliary Equipment Maintenance	5	-	-	5
39263	Total Quality Management and Total Productive Maintenance	4	-	-	4
39264	Machine Tool Reconditioning and Overhauling	4	-	-	4
39265	Engineering Management	4	-	-	4
39266	CNC Programming and Simulation Lab	-	-	4	4
39267	Maintenance Lab - I	-	-	4	4
30002	Life and Employability skill Practical**	-	-	4	4
Seminar		1	-	-	1
Total		23	-	12	35

VII SEMESTER

S.No	Subject	Hours per week			
		Theory	Tutorial /Drawing	Practical	Total
39271	Maintenance Lab - II			4	4
32055	Process Automation Practical*			4	4
39273	Project Work*			4	4
39292	Industrial Training –II (Report Writing & Viva Voce)				NA

* Common with DME.

* Common with all branches.

www.binils.com

M SCHEME

Implemented from 2015 - 2016

2022: DIPLOMA IN MECHANICAL ENGINEERING (Machine Tool Maintenance and Repairs (sandwich) Scheme of Examination

III SEMESTER

		Examination Marks			Minimum For pass	Duration of Examination hours
		Internal Assessment Marks	Board Exam Marks	Total marks		
39231	Solid Mechanics and Fluid Power	25	75	100	40	3
39232	Industrial Production Technology – I	25	75	100	40	3
39233	Lubrication Technology	25	75	100	40	3
32033	Machine Drawing*	25	75	100	40	3
32034	Computer Application & CAD Practical*	25	75	100	50	3
32036	Lathe and Drilling Practical*	25	75	100	50	3
32045	Strength of Material and Fluid Mechanics Practical*	25	75	100	50	3
Total		175	525	700		

IV SEMESTER

		Examination Marks			Minimum For pass	Duration of Examination hours
		Internal Assessment Marks	Board Exam Marks	Total marks		
32037	Metrology and Metallography Practical *	25	75	100	50	3
32035	Foundry and Welding Practical*	25	75	100	50	3
39291	Industrial Training – I (Report Writing & Viva Voce)	25	75	100	50	3
Total		75	225	300		

V SEMESTER

		Examination Marks			Minimum For pass	Duration of Examination hours
		Internal Assessment Marks	Board Exam Marks	Total marks		
39251	Industrial Production Technology - II	25	75	100	40	3
39252	Thermal and Renewable Energy	25	75	100	40	3
39253	Engineering Metrology	25	75	100	40	3
39254	Maintenance of Machine Drive Elements	25	75	100	40	3
32044	Electrical Drives and Control*	25	75	100	40	3
32046	Special Machine Practical*	25	75	100	50	3
32047	Electrical Drives and Control Practical*	25	75	100	50	3
39258	Thermal Equipment Performance Practical	25	75	100	50	3
Total		200	600	800		

VI SEMESTER

S.No	Subject	Examination Marks			Minimum For pass	Duration of Examination hours
		Internal Assessment Marks	Board Exam Marks	Total marks		
39261	Industrial Automation	25	75	100	40	3
39262	Auxiliary Equipment Maintenance	25	75	100	40	3
39263	Total Quality Management and Total Productive Maintenance	25	75	100	40	3
39264	Machine Tool Reconditioning and Overhauling	25	75	100	40	3
39265	Engineering Management	25	75	100	40	3
39266	CNC Programming and Simulation Lab	25	75	100	50	3
39267	Maintenance Lab - I	25	75	100	50	3
30002	Life and Employability skill Practical**	25	75	100	50	3
Total		200	600	800		

VII SEMESTER

S.No	Subject	Examination Marks			Minimum For pass	Duration of Examination hours
		Internal Assessment Marks	Board Exam Marks	Total marks		
39271	Maintenance Lab - II	25	75	100	50	3
32055	Process Automation Practical*	25	75	100	50	3
39273	Project Work*	25	75	100	50	3
39292	Industrial Training –II (Report Writing & Viva Voce)	25	75	100	50	3
Total		100	300	400		

* Common with DME.

* Common with all branches.

Board Examination - Question paper pattern

Common for all theory subjects except Machine Drawing

and Design of Machine Elements

PART A - (1 to 8) 5 Questions are to be answered out of 8 questions for 2 marks each. (Question No. 8 will be the compulsory question and can be asked from any one of the units) (From each unit maximum of two 2 marks questions alone can be asked)

PART B - (9 to 16) 5 Questions are to be answered out of 8 questions for 3 marks each. (Question No. 16 will be the compulsory question and can be asked from any one of the units) (From each unit maximum of two 3 marks questions alone can be asked)

PART C - (17 to 21) Five Questions will be in the Either OR Pattern. Students have to answer these five questions. Each question carries 10 marks. (Based on the discretion of the question setter, he/she can ask two five mark questions (with sub division A & sub division B) instead of one ten marks question if required)

Any tables required should be mentioned in the question paper. Steam table, Design Data Book, Mollier chart, Psychometric Chart etc..



DIRECTORATE OF TECHNICAL EDUCATION

**DIPLOMA IN MECHANICAL ENGINEERING (MACHINE TOOL MAINTENANCE
AND REPAIRS) (SANDWICH)**

II YEAR

M – SCHEME

III SEMESTER

2015 -2016 onwards

www.binils.com

39231

SOLID MECHANICS AND FLUID POWER

CURRICULUM DEVELOPMENT CENTRE

M-SCHEME

(Implements from the Academic year 2015-2016 onwards)

Course Name: DIPLOMA IN MECHANICAL ENGINEERING (Machine Tool Maintenance and Repairs)

Course Code: 2022

Subject Code: 39231

Semester: III

Subject Title: SOLID MECHANICS & FLUID POWER

No. of Weeks per Semester: 15 weeks

Subject	Instructions		Examination			Duration
	Hours / Week	Hours /Semester	Marks			
SOLID MECHANICS & FLUID POWER	6	90	Internal Assessment	Board Examination	Total	3 Hrs
			25	75	100	

Topics and Allocation of Hours:

S.No	Topic	Hours
1	Deformation of Metals	17
2	Torsion And Springs	17
3	Properties of Fluids, Elements of Hydraulic Systems, Pumps And Valves	17
4	Hydraulic Cylinders, Intensifiers, Hydraulic Motors, Accumulators And Hydraulic System Design	17
5	Pneumatic Power Unit, Cylinders And Motors, Pneumatic Valves, Basic Pneumatic Circuits	17
	Test and Revision	5
	Total	90

Rational:

Hydraulics plays an important role in the automatic machine circuit. Further the student should have knowledge about deformation of metals with the application of force. Hence this paper is introduced.

Objective:

- To know about Deformation of Metals

- To know about Torsion And Springs
- To know Properties of Fluids, Elements of Hydraulic Systems, Pumps And Valves
- To know about Hydraulic Cylinders, Intensifiers, Hydraulic Motors, Accumulators And Hydraulic System Design
- To know about Pneumatic Power Unit, Cylinders And Motors, Pneumatic Valves, Basic Pneumatic Circuits

SOLID MECHANICS & FLUID POWER
Detailed Syllabus

Unit	Name of the Topic	Hours
I	<p>DEFORMATION OF METALS</p> <p>Mechanical properties of materials: Engineering materials – Ferrous and non ferrous materials -Definition of mechanical properties such as strength – elasticity, plasticity, ductility, malleability, stiffness, toughness, brittleness, hardness, wear resistance, machinability, castability and weldability - Alloying elements-effect of alloying element - Fatigue, fatigue strength, creep – temperature creep – cyclic loading and repeated loading – endurance limit.</p> <p>Simple stresses and strains: Definition – Load, stress and strain – Classification of force systems – tensile, compressive and shear force systems – Behavior of mild steel in tension up to rupture – Stress – Strain diagram – limit of proportionality – elastic limit – yield stress – breaking stress – Ultimate stress – percentage of elongation and percentage reduction in area – Hooke’s law – Definition – Young’s modulus - working stress, factor of safety, load factor, shear stress and shear strain - modulus of rigidity. Linear strain – Deformation due to tension and compressive force – Simple problems in tension, compression and shear force. Definition – Lateral strain – Poisson’s ratio – volumetric strain – bulk modulus – volumetric strain of rectangular and circular bars – problems connecting linear, lateral and volumetric deformation – Elastic constants and their relationship - Problems on elastic constants - Definition – Composite bar – Problem in composite bars</p>	17

	subjected to tension and compression	
II	<p>TORSION AND SPRINGS</p> <p>Theory of torsion – Assumptions – torsion equation – strength of solid and hollow shafts – power transmitted – Definition – Polar modulus – Torsional rigidity – strength and stiffness of shafts – comparison of hollow and solid shafts in weight and strength considerations – Advantages of hollow shafts over solid shafts – Problems.</p> <p>Types of springs – Laminated and coiled springs and applications – Types of coiled springs – Difference between open and closely coiled helical springs – closely coiled helical spring subjected to an axial load – problems to determine shear stress, deflection, stiffness and resilience of closed coiled helical springs</p>	17
III	<p>PROPERTIES OF FLUIDS, ELEMENTS OF HYDRAULIC SYSTEMS, PUMPS AND VALVES</p> <p>Introduction - Definition of fluid - Classification of Fluids - ideal and real fluids -Properties of a fluid – definition and units - Pressure-units of Pressure - Pressure head-atmospheric, gauge and absolute pressure.</p> <p>Introduction – elements of a hydraulic system – advantages of hydraulics systems – disadvantages – qualities of a good hydraulic fluid – hydraulic symbols.</p> <p>Hydraulic pumps and control valves: Principles of operation of non positive displacement pumps –centrifugal pumps – volute – diffuser – propeller pumps – mixed flow pumps – principles of operation of positive displacement pumps – rotary pumps – gear – lobe - vane – piston – reciprocating pumps.</p> <p>Control valves: Introduction to valves – types – pressure control valves - relief valve – pressure reducing valve – sequence valves – pressure switches – directional control valves– types only – solenoid controlled — check valves – foot</p>	17

	valve	
IV	<p>HYDRAULIC CYLINDERS, INTENSIFIERS, HYDRAULIC MOTORS, ACCUMULATORS AND HYDRAULIC SYSTEM DESIGN</p> <p>Hydraulic cylinders: Non-rotating type – single acting, double acting – rotating type – description - applications.</p> <p>Intensifiers: Type – single acting – double acting – purpose – construction and its uses.</p> <p>Accumulators: Types – dead weight, spring loaded, air or gas operated – purpose construction and its uses</p> <p>Hydraulic motors: Types – gear – lobe – vane – purpose – construction and its uses.</p> <p>Hydraulic system design: Hydraulic circuits applications – automatic systems – machine tools –shaping machine, milling machine, grinding machine – trouble shooting and maintenance and safety</p>	17
V	<p>PNEUMATIC POWER UNIT, CYLINDERS AND MOTORS, PNEUMATIC VALVES, BASIC PNEUMATIC CIRCUITS</p> <p>Pneumatic power unit: Construction and principles of operation of the compressor – reciprocating, rotary, centrifugal and axial flow – air tank construction pressure switch control – FRL unit.</p> <p>Pneumatic cylinders: Types of air cylinders – single acting, double acting – construction – cushion assembly – piston and piston seals – applications</p> <p>Air motor: Vane types – construction – application.</p> <p>Pneumatic valves: Pneumatic controls – directional control valves – basic construction of valves –control – impulse valve – speed regulators – quick exhaust value – time delay valve – logic functions– shuttle valve – twin pressure valve - solenoid operated valve</p> <p>Basic pneumatic circuits: Symbols – basic pneumatic circuits</p>	17

	– impulse operation – speed control sequencing of motion	
--	--	--

Text Books:

1. Strength of Materials ,R.K. Bansal,, Laxmi Publications Pvt. Ltd., New Delhi, 3rd Edition, 2010.
2. Strength of materials, S.S.Rattan, Tata Mcgraw hill, New Delhi,2008, ISBN 9780070668959,
3. Strength of Materials, B K Sarkar, I Edition, 2003 Tata Mcgraw hill, New Delhi.
4. Engineering mechanics, R.K. Bansal, Laxmi Publications Pvt. Ltd., New Delhi,

Reference Books:

1. Hydraulics & Pneumatics Power for production Harry L Stewart – Industrial Press Inc, New York - 1977
2. Pneumatic circuit by Harry L. Stewart – Audel Series – 1976
3. Fundamentals of pneumatic control Engg – Text book By Festo Company -1985
4. Introduction to Pneumatics – Text Book by Festo Company - 1983

www.binils.com



DIRECTORATE OF TECHNICAL EDUCATION

**DIPLOMA IN MECHANICAL ENGINEERING (MACHINE TOOL MAINTENANCE
AND REPAIRS) (SANDWICH)**

II YEAR

M – SCHEME

III SEMESTER

2015 -2016 onwards

39232

INDUSTRIAL PRODUCTION TECHNOLOGY – I

CURRICULUM DEVELOPMENT CENTRE

M-SCHEME

(Implements from the Academic year 2015-2016 onwards)

Course Name: DIPLOMA IN MECHANICAL ENGINEERING (Machine Tool

Maintenance and Repairs)

Course Code: 2022

Subject Code: 39232

Semester: III

Subject Title: INDUSTRIAL PRODUCTION TECHNOLOGY – I

No. of Weeks per Semester: 15 weeks

Subject	Instructions		Examination			Duration
	Hours / Week	Hours /Semester	Marks			
Industrial Production Technology – I	5	75	Internal Assessment	Board Examination	Total	3 Hrs
			25	75	100	

Topics and Allocation of Hours:

S.No	Topic	Hours
1	Foundry and Welding	14
2	Forging and Press Working	14
3	Powder Metallurgy And Heat Treatment	14
4	Lathe and Work Holding Devices	14
5	Semi-Automatic Lathes And Automatic Lathes	14
6	Test and Revision	5
	Total	75

Rational:

The students studying maintenance course should have a fundamental knowledge manufacturing process like forging, welding, foundry and machines like lathe. Further they should have knowledge about heat treatment process.

Objectives:

- To know about Foundry and Welding

- To know Forging and Press Working
- To know Powder Metallurgy And Heat Treatment
- To know Lathe and Work Holding Devices
- To know Semi-Automatic Lathes And Automatic Lathes

Industrial Production Technology – I

Detailed Syllabus

Unit	Name of the Topic	Hours
I	<p>FOUNDRY and WELDING</p> <p>Foundry: Pattern – Pattern Materials – types – single piece (solid) and split type only – allowances – moulding – moulding tools and boxes – moulding sands – classifications and properties – green sand moulding – dry sand moulding – casting – sand casting using green and dry sand moulds – cleaning of casting and safety practices in foundry</p> <p>Welding: - Arc welding definition – arc welding equipment – arc welding methods – carbon arc, metal arc, metal inert gas (MIG), tungsten inert gas (TIG). Gas welding: definition – oxy-acetylene welding – resistance welding – definition – classification of resistance welding – butt – spot – seam projection welding – safety practices in welding</p>	14
II	<p>FORGING AND PRESS WORKING</p> <p>Forging: Hot working, advantages of hot working – hot working operations – rolling – forging – hammer or smith forging, drop forging, upset forging, press forging – roll forging</p> <p>PRESS WORKING: Types of presses – mechanical and hydraulic presses – press tools and accessories – press working operations – bending operations – angle bending – channel bending – curling – drawing – shearing operations – blanking – piercing – trimming – notching – lancing – shaving – parting off.</p>	14
III	<p>POWDER METALLURGY AND HEAT TREATMENT</p> <p>POWDER METALLURGY: Methods of manufacturing metal</p>	14

	<p>powders – atomization, reduction and electrolysis deposition – compacting – sintering – sizing – infiltration – mechanical properties of parts made by powder metallurgy – design rule for the powder metallurgy process</p> <p>Heat Treatment: Purpose – procedures – applications of various heat treatment process – Iron carbide equilibrium diagram – full annealing – process annealing – stress relief annealing – spheroidise annealing – isothermal annealing – normalizing – hardening – tempering – quenching medium – different types of quenching medium – case hardening – pack hardening – carburizing – cyaniding – nitriding – induction Hardening – flame hardening</p>	
IV	<p>LATHE AND WORK HOLDING DEVICES</p> <p>LATHE: Definition – specifications – simple sketches – principle parts – headstock – back geared type – all geared type – tumbler gear mechanism – quick change gear box – apron – mechanism – carriage – cross slide – automatic, longitudinal and cross feed mechanism – tailstock and its functions- machining operation done on lathe – straight turning – step turning – taper turning – thread cutting – knurling – facing – boring – chamfering – cutting feed – depth of cut.</p> <p>WORK HOLDING DEVICES: Face plate – three jaw chuck – four jaw chuck – catch plate and carrier – types of centre's.</p>	14
V	<p>SEMI AUTOMATIC LATHES AND AUTOMATIC LATHES</p> <p>SEMI-AUTOMATIC LATHES: Types of semi automatic lathes – capstan and turret lathes – difference between turret and capstan – tool and work holding devices – self opening die head – collapsible taps</p> <p>AUTOMATIC LATHES: Automatic lathe – classification of single spindle automatic lathe – principle of automatic lathes – automatic screw cutting machines – multi spindle automatic lathes</p>	14

Text Books:

- 1) Elements of workshop Technology Volume I & II – Hajra Chowdry & Bhattacharaya - 11th Edition - Media Promoters & Publishers Pvt. Ltd., Seewai Building 'B', 20-G, Noshir Bharucha Marg, Mumbai 400 007 – 2007.
- 2) A Text book of workshop Technology - R.S.Khurmi & J. K. Gupta - 2nd Edition, S.Chand & Co., Ram Nagar, New Delhi – 2002.

Reference Books:

- 1) Manufacturing process – Begeman - 5th Edition -McGraw Hill, New Delhi 1981.
- 2) Workshop Technology- WAJ Chapman - Volume I, II, & III – Vima Books Pvt. Ltd., 4262/3, Ansari Road, Daryaganj, New Delhi 110 002.
- 3) Workshop Technology – Raghuwanshi - Khanna Publishers. Jain & Gupta, Production Technology, Edn. XII, Khanna Publishers, 2-B, North Market, NAI Sarak, New Delhi 110 006 - 2006
- 4) Production Technology - P. C. SHARMA - Edn. X - S.Chand & Co. Ltd., Ram Nagar, New Delhi 110 055 - 2006
- 5) Production Technology – HMT- Edn. 18 - published by Tata McGraw Hill publishing Co. Ltd., 7 West Patel nagar, New Delhi 110 008. – 2001.
- 6) Manufacturing Engineering & Technology - Kalpakjian,



DIRECTORATE OF TECHNICAL EDUCATION

**DIPLOMA IN MECHANICAL ENGINEERING (MACHINE TOOL MAINTENANCE
AND REPAIRS) (SANDWICH)**

II YEAR

M – SCHEME

III SEMESTER

2015 -2016 onwards

39233 - LUBRICATION TECHNOLOGY

CURRICULUM DEVELOPMENT CENTRE

M-SCHEME

(Implements from the Academic year 2015-2016 onwards)

Course Name: DIPLOMA IN MECHANICAL ENGINEERING (Machine Tool Maintenance and Repairs)

Course Code: 2022

Subject Code: 39233

Semester: III

Subject Title: LUBRICATION TECHNOLOGY

Subject	Instructions		Examination			
	Hours / Week	Hours /Semester	Marks		Duration	
Lubrication Technology – I	5	75	Internal Assessment	Board Examination	Total	3 Hrs
			25	75	100	

Topics and Allocation of Hours:

Unit	Topic	Hours
1	Lubrication Principles & Practice	14
2	Lubrication Performance Evaluation	14
3	Organization of Lubrication process	14
4	Failure Analysis And Case Studies	14
5	Industrial Lubrication	14
	Test and revision	5
	Total	60

Rational:

The people who are in the maintenance field should a thorough knowledge about Lubrication Principles, Lubricants Performance and failure analysis of machine component.

Objectives:

- To know the Lubrication Principles & Practice
- To know the Lubrication Performance Evaluation
- To know the Organization of Lubrication process
- To know the Failure Analysis And Case Studies
- To know the Industrial Lubrication

**Lubrication Technology
Detailed Syllabus**

Unit	Name of the Topic	Hours
I	LUBRICATION PRINCIPLES & PRACTICE Friction and wear: Friction – static friction – kinetic friction – friction at lubricated surfaces – sources for reduction of friction. Wear – effects of wear, wear and damage – types of wear. a) Lubrication principle: Lubrication- Boundary lubrication – hydro static lubrication – hydro dynamic lubrication – lubricant – friction and purpose of lubrication – types of lubrication – solid – liquid – semi solid – synthetic liquid lubricants – properties – viscous – compressibility – conductivity – thermal & electrical – density – oiliness and wetability - oxidation characteristics – colour – odourness – applications. b) General Lubrication practice: Lubrication sources and composition – additives – detergents – purpose – selecting the lubricant under various conditions – lubricant in metal working seals and packing	14
II	LUBRICATION PERFORMANCE EVALUATION: Lubricant performance evaluation – lubricants for specific applications – turbine oils – engine oils – cutting fluids – cylinder oils – hydraulic oils – rust preventives – anti oxidants – oxidation stability – standard test for physical & chemical properties – film strength test – falex machine – Almen machine – SAE machine – acidity, basicity, neutralization number – aniline point – carbon residue – cloud, pour and flock points – corrosion – evaporation and volatility – flash and fire point – foaming – penetration of greases – precipitation number –	14

	dropping point of grease – viscosity – water content. Engine performance test – thermal stability – oxidation stability – rust and corrosion prevention.	
III	ORGANISATION OF LUBRICATION PROCESS Organization For Lubrication: Lubrication Organization – Records And Scheduling - Handling And Storage – Lubrication Condition And Disposal – Marketing – Conservation Of Lubrication – Recycling Of Used Lubricants – Re Doping - Disposal Of Sludge – Lubrication Chart For Machine Tool – Lathe, Milling Machine	14
IV	FAILURE ANALYSIS AND CASE STUDIES: Lubrication mechanical elements – bearings – types – bush bearings – plain – ball – roller – taper roller – lubrication of bearings – effects of failure of lubricants in bearings – gears – types – spur – helical – bevel – rack and pinion – worm gear – herring bone – Lubrication of gear – effect of failure of lubricants in gear – gas bearings - applications – hydro dynamic – hydro static bearings. Chain – types of chain – roller chain – effect of failure of lubricants in chain- Lubrication of wire ropes for material handling.	14
V	INDUSTRIAL LUBRICATION: Industrial lubrication – methods – manual – drop feed – wick feed – splash – forced aerosol lubrication – pressure circulating system – centralized lubrication system – built in lubrication – pumps – instrumentation and control – lubrication of specific equipment – electric motor – automotive engines – machine tools – precision grinder – central lathe – construction equipment	14

Text Book:

1. Industrial Maintenance by H. P. Garg.

Reference books:

1. Standard Hand Book of Lubricating by James J.O' Corner, John Boyd, Eugene A. Avallone
2. Fundamentals of Mechanical maintenance By Mukund K. Nimbarate



DIRECTORATE OF TECHNICAL EDUCATION
DIPLOMA IN MECHANICAL ENGINEERING

[MTMR]

M SCHEME

2015 -2016 onwards

II YEAR

III SEMESTER

www.binils.com

32033 – MACHINE DRAWING

CURRICULUM DEVELOPMENT CENTRE

M-SCHEME

(Implements from the Academic year 2015-2016 onwards)

Course Name : DIPLOMA IN MECHANICAL ENGINEERING [MTMR]
Course Code : 2022
Subject Code : 32033
Semester : III
Subject Title : MACHINE DRAWING

TEACHING AND SCHEME OF EXAMINATIONS:

No. of Weeks per Semester: 15 Weeks

Subject	Instructions		Examination			Duration
	Hours /Week	Hours/ Semester	Marks			
Machine Drawing	4	60	Internal Assessment	Board Examination	Total	3 Hrs
			25	75	100	

Topics and Allocation of Hours:

Unit	Topics	Hours
I	Sectional Views	5
II	Limits, Fits and Tolerances	5
III	Surface Texture	5
IV	Keys, Screw threads and Threaded fasteners	5
V	Assemble drawing	33
	TEST AND REVISION	7
	Total	60

RATIONALE:

Manufacturing of various parts start from the basic drawing of components. The assembly of components is also carried out from the drawing. So drawing is an important subject to be studied by the students to carry and complete the production and assembly process successfully.

OBJECTIVES:

- Appreciate the need for sectional view and types of sections.
- Draw sectional views using different types of sections.
- Explain the use of threaded fasteners and the types of threads.
- Compare hole basis system with shaft basis system.
- Select different types of fits and tolerance for various types of mating parts.
- Appreciate the importance of fits and tolerance.

MACHINE DRAWING DETAILED SYLLABUS

Contents: Theory

Unit	Name of the Topic	Hours
I	SECTIONAL VIEWS	5
	Review of sectioning – Conventions showing the section – symbolic representation of cutting plane- types of section – full section, half section, offset section, revolved section, broken section, removed section – section lining.	
II	LIMITS, FITS AND TOLERANCES	5
	Tolerances – Allowances – Unilateral and Bilateral tolerances. Limits – Methods of tolerances – Indication of tolerances on linear dimension of drawings – Geometrical tolerances – application – Fits – Classifications of fits – Selection of fits – examples	
III	SURFACE TEXTURE	5
	Surface texture – importance – controlled and uncontrolled surfaces – Roughness – Waviness – lay – Machining symbols	
IV	KEYS, SCREW THREADS AND THREADED FASTENERS	5
	Types of fasteners – temporary fasteners – keys – classification of keys – Heavy duty keys – light duty keys. Screw thread – Nomenclature – different types of thread profiles – threads in sections – threaded fasteners – bolts – nuts – through bolt – tap bolt, stud bolt – set screw – cap screws – machine screws – foundation bolts	

V MANUAL DRAWING PRACTICE

33

Detailed drawings of following machine parts are given to students to assemble and draw the Elevations / Sectional elevations / Plan / and Side views with dimensioning and bill of materials

1. Sleeve & Cotter joint
2. Knuckle joint
3. Screw Jack
4. Foot step bearing
5. Plummer Block
6. Universal Coupling
7. Simple Eccentric
8. Machine Vice
9. Protected type flanged coupling
10. Swivel bearing.

Books:

- 1) Machine Drawing, P.S. Gill, Katsan Publishing House, Ludiana
- 2) A Text book of Engineering Drawing, R.B. Gupta, Satya Prakasan, Technical India Publications, New Delhi
- 3) Mechanical Draughtsmanship, G.L. Tamta, Dhanpat Rai & Sons, Delhi
- 4) Geometrical and Machine Drawing, N.D. Bhatt, Cheroter book stalls, Anand, West Railway
- 5) Engineering Drawing, D.N. Ghose, Dhanpat Rai & Sons, Delhi

BOARD EXAMINATIONS

Question Pattern

Time: 3 Hrs

Max Marks : 75

Note: All the questions will be answered in drawing sheet only

PART A: (7 x 5 = 35)

Theory questions: (1 TO 8)

Two questions from each unit (I to IV) will be asked.

Answer any seven questions from the given eight questions.

PART B: 40 Marks (Either A or B.)

Answer any one question by selecting either A or B.

9. A. Assemble and Draw any two views and bill of materials.

(OR)

- B. Assemble and Draw any two views and bill of material



DIRECTORATE OF TECHNICAL EDUCATION
DIPLOMA IN MECHANICAL ENGINEERING

[MTMR]

M SCHEME

2015 -2016 onwards

www.binils.com

II YEAR

III SEMESTER

**32034 – COMPUTER APPLICATIONS AND
CAD PRACTICAL**

CURRICULUM DEVELOPMENT CENTRE

M-SCHEME

(Implements from the Academic year 2015-2016 onwards)

Course Name : DIPLOMA IN MECHANICAL ENGINEERING [MTMR]
Course Code : 2022
Subject Code : 32034
Semester : III
Subject Title : COMPUTER APPLICATIONS AND CAD PRACTICAL

TEACHING AND SCHEME OF EXAMINATIONS:

No. of weeks per semester: 15 Weeks

Subject	Instructions		Examination			Duration
	Hours / Week	Hours / Semester	Marks			
Computer Applications and CAD practical	6	90	Internal Assessment	Board Examination	Total	3 Hrs
			25	75	100	

OBJECTIVES:

On completion of the exercises, the students must be able to

- Use the different facilities available in the word processor
- Analyze the data sheet
- Create and manipulate the database
- Prepare PowerPoint presentation
- Practice on CADD commands in making 2D Drawings.
- Draw assembled drawings using CADD.
- Draw sectional views using different types of sections.

PART – A: COMPUTER APPLICATIONS (30 Hrs)

WORD PROCESSING

Introduction – Menus – Tool bar – Create – Edit – Save – Alignment – Font Size – Formatting – Tables – Fill Colors – Page Setup - Preview – Water marking – Header – Footer – Clip art.

Exercises

1. Create a news letter of three pages with two columns text. The first page contains some formatting bullets and numbers. Set the document background colour and add 'confidential' as the watermark. Give the document a title which should be displayed in the header. The header/ footer of the first page should be different from other two pages. Also, add author name and date/ time in the header. The footer should have the page number.

2. Create the following table using align, border, merging and other attributes.

<u>DIRECTORATE OF TECHNICAL EDUCATION</u>					
e-governance particulars					
Register Number	June	July	August	September	Cumulative %
16304501					
16304502					
16304503					
16304504					
16304505					

SPREADSHEET

Introduction – Menus – Tool bar – Create – Edit – Save – Formatting cells – Chart wizard – Fill Colors – Creating and using formulas – Sorting – Filtering.

Exercises

3. Create a table of records with columns as Name and Donation Amount. Donation amount should be formatted with two decimal places. There should be at least twenty records in the table. Create a conditional format to highlight the highest donation with blue colour and lowest donation with red colour. The table should have a heading.

4. Prepare line, bar and pie chart to illustrate the subject wise performance of the class for any one semester.

DATABASE

Introduction – Menus – Tool bar – Create – Edit – Save – Data types – Insert – Delete – Update – View – Sorting and filtering – Queries – Report – Page setup – Print.

Exercises

5. Prepare a payroll for employee database of an organization with the following details: Employee Id, Employee name, Date of Birth, Department and Designation, Date of appointment, Basic pay, Dearness Allowance, House Rent Allowance and other deductions if any. Perform simple queries for different categories.

6. Design a pay slip for a particular employee from the above database.

PRESENTATION

Introduction – Menus – Tool bar – Create – Edit – Save – Slide transition – Insert image – Hyper link – Slide numbers – View slide show with sound – Photo album – Clip art.

Exercises

7. Make a presentation with atleast 10 slides. Use different customized animation effects on pictures and clip art on any four of the ten slides.

PART – B: CAD (60 Hrs)

INTRODUCTION

Introduction – History of CAD – Applications – Advantages over manual drafting – Hardware requirements – Software requirements – Windows desktop – CAD screen interface – menus – Tool bars – How to start CAD – How to execute command – types of co-ordinate systems – Absolute – Relative – Polar.

DRAWING AIDS AND EDITING COMMANDS

Creating objects (2D) – Using draw commands – Creating text – Drawing with precision – Osnap options – drafting settings – drawing aids – Fill, Snap, Grid, Ortho lines – Function keys - Editing and modify commands – Object selection methods – Erasing object – Oops - Cancelling and undoing a command – Copy – Move – Array

– Offset – Scale – Rotate – Mirror – Break – Trim – Extend – Explode. Divide – Measure – stretch – Lengthen – Changing properties – Color – line types –LT scale – Matching properties – Editing with grips – Pedit – Ddedit – Mledit.

BASIC DIMENSIONING, HATCHING, BLOCKS AND VIEWS

Basic dimensioning – Editing dimensions – Dimension styles – Dimension system variables. Machine drawing with CAD. Creation of blocks – Wblock – inserting a block – Block attributes – Hatching –Pattern types – Boundary hatch – working with layers - Controlling the drawing display – Blipmode – View group commands – Zoom, redraw, regen, regenauto, pan, viewres – Real time zoom. Inquiry groups – calculating area – Distance – Time – Status of drawing – Using calculator.

CAD EXERCISES

Detailed drawings of following machine parts are to be given to students. Draw the assembled views (two views only) and bill of materials.

The elevation / sectional elevation / plan / sectional plan / side view with dimensioning.

1. Sleeve & Cotter joint
2. Screw jack
3. Plummer Block
4. Simple Eccentric
5. Machine Vice
6. Protected type flanged coupling

Reference Books:

- 1) Inside AutoCAD - D. Raker and H. Rice - BPB Publications, NewDelhi
- 2) Engineering Drawing and Graphics + AutoCAD – K.Venugopal, - New Age International Publications
- 3) AutoCAD with Applications - Sham Tickoo - Tata Mcgraw Hill.

Board of Examination

Note: All the exercises have to be completed. Two exercises will be given for examination by selecting one exercise in each PART.

All the exercises should be given in the question paper and students are allowed to select by a lot.

Record note book should be submitted during examination.

ALLOCATION OF MARKS

PART - A	:	25 marks
Editing / Creation	-	10
Formatting	-	10
Printout	-	5
PART - B	:	45 marks
Drafting	-	20
Assembly	-	10
Dimensioning	-	10
Printout	-	5
Viva-voce	:	05 marks
Total	:	75 marks

LIST OF EQUIPMENT

1. Personal computer – 30 Nos.
2. Printer – 1 No.
3. Required Softwares : Office Package, CAD Package – Sufficient to the strength.



DIRECTORATE OF TECHNICAL EDUCATION
DIPLOMA IN MECHANICAL ENGINEERING

[MTMR]

M SCHEME

2015 -2016 onwards

www.binils.com
II YEAR
III SEMESTER

32036 – LATHE AND DRILLING PRACTICAL

CURRICULUM DEVELOPMENT CENTRE

M-SCHEME

(Implements from the Academic year 2015-2016 onwards)

Course Name : DIPLOMA IN MECHANICAL ENGINEERING [MTMR]
Course Code : 2022
Subject Code : 32036
Semester : III
Subject Title : Lathe and Drilling Practical

TEACHING AND SCHEME OF EXAMINATIONS:

No. of weeks per semester: 15 Weeks

Subject	Instructions		Examination			
	Hours/ Week	Hours/ Semester	Marks		Duration	
Lathe and Drilling Practical	4	60	Internal Assessment	Board Examination	Total	3 Hrs
			25	75	100	

OBJECTIVES:

- Identify the parts of a lathe.
- Identify the work holding devices.
- Set the tools for various operations.
- Operate the lathe and machine a component using lathe.
- Identify the parts of drilling machine.
- Perform the various drilling operations.
- Identify the various tools and its holding devices.
- Identify the work holding devices.
- Prepare the record of work for the exercises.

Lathe section:

1. Introduction of safety in operating machines.
2. Study of lathe and its parts.
3. Types of tools used in lathe work.
4. Study of work holding devices and tool holding devices.

5. Setting of work and tools.
6. Operation of lathe.
7. Practice on a lathe.
8. Types of measuring instruments and their uses.

Exercises:

Make the following jobs in the lathe. Raw material \square 32 mm M.S. Rod

1. Facing, Step turning & Chamfering

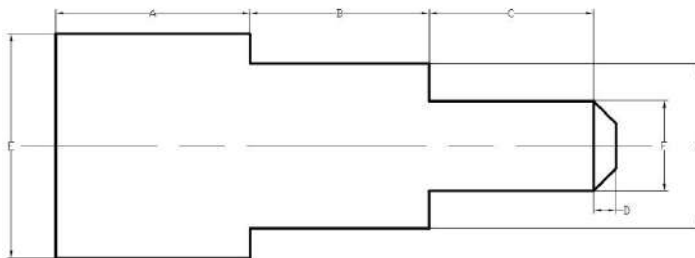

Dimensions			
Sl.No	Part Name	Actual	Obtained

2. Step turning & Groove cutting

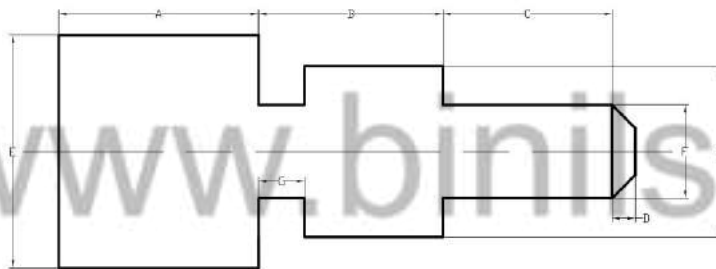

Dimensions			
Sl.No	Part Name	Actual	Obtained

3. Step turning & Taper turning

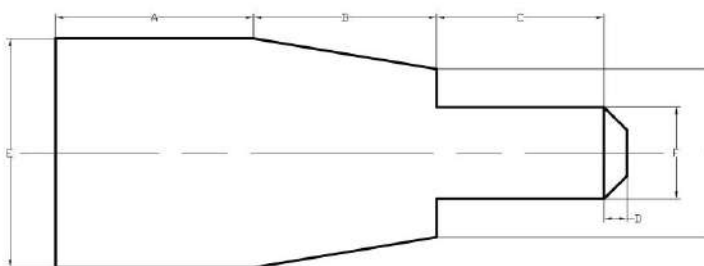

Dimensions			
Sl.No	Part Name	Actual	Obtained

4. Step turning & Knurling

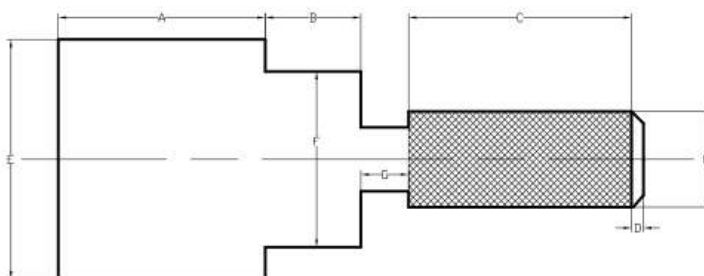

Dimensions			
Sl.No	Part Name	Actual	Obtained

5. Step turning & Thread cutting (L.H.)

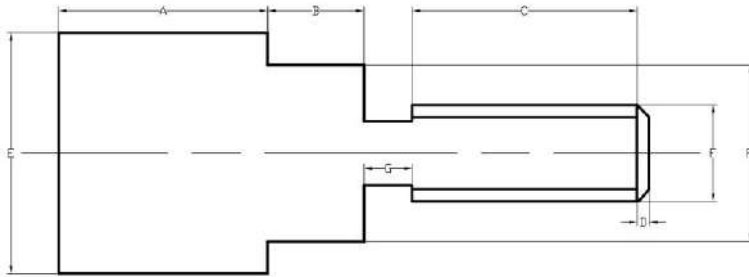

Dimensions			
Sl.No	Part Name	Actual	Obtained

6. Step turning & Thread cutting (R.H.)

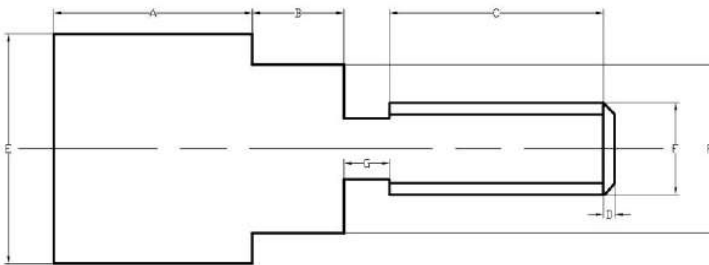

Dimensions			
Sl.No	Part Name	Actual	Obtained

7. Bush: Turning & Drilling

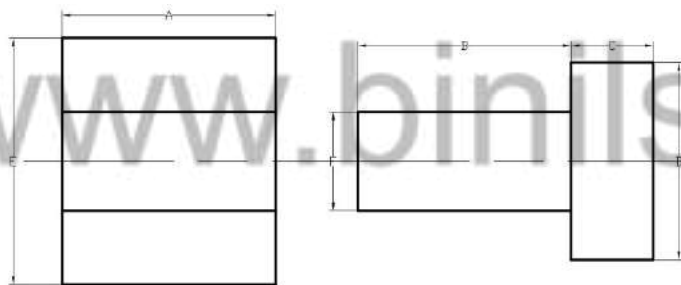

Dimensions			
Sl.No	Part Name	Actual	Obtained

8. Eccentric turning

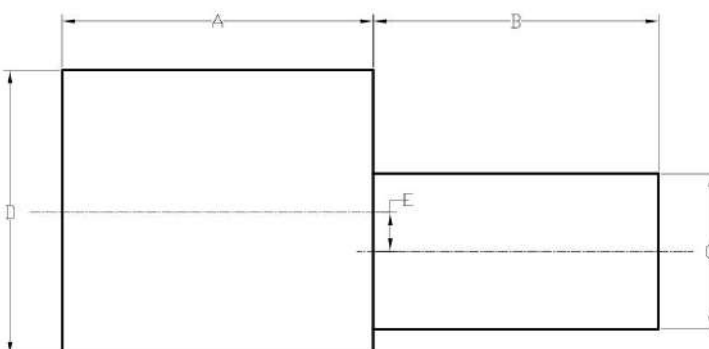

Dimensions			
Sl.No	Part Name	Actual	Obtained

Drilling section:

1. Introduction of safety in operating machines.
2. Study of drilling machines and its parts.
3. Study the types of tools used.
4. Study of work holding devices and tool holding devices.
5. Setting of work and tools.
6. Operation and practice.
7. Types of measuring instruments and their uses.

Exercises:

Make the following jobs in the drilling machine.

Raw material 50mm X 50mm X 20 mm thick M.S. Flat

1. Drilling & Tapping

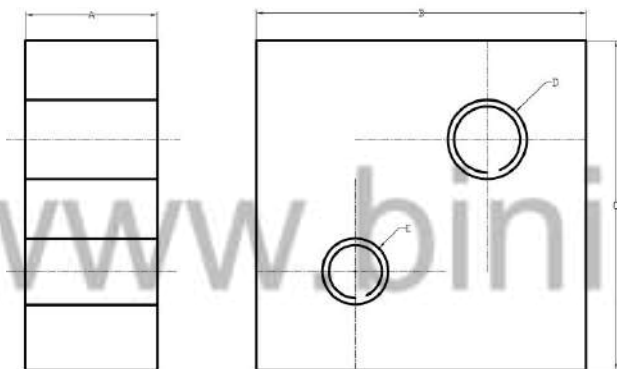

Dimensions			
Sl.No	Part Name	Actual	Obtained

2. Drilling & Counter boring

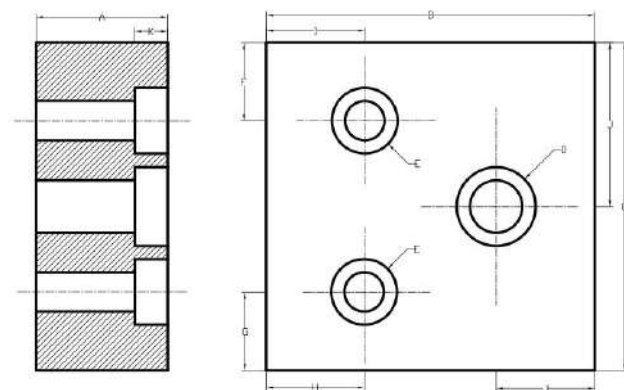

Dimensions			
Sl.No	Part Name	Actual	Obtained

3. Drilling & Counter sinking

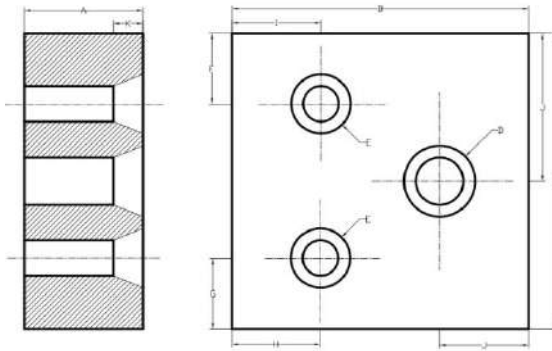

Dimensions			
Sl.No	Part Name	Actual	Obtained

4. Drilling and Reaming – Radial drilling machine

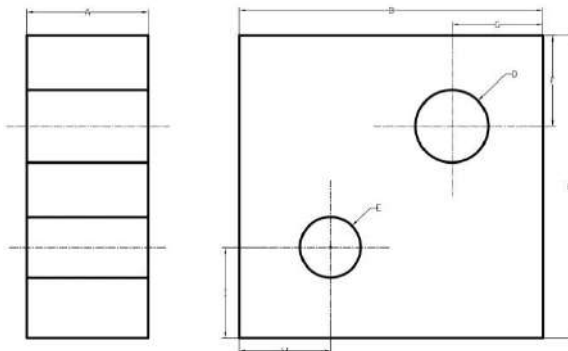

Dimensions			
Sl.No	Part Name	Actual	Obtained

www.binils.com

BOARD EXAMINATION

Note: All the exercises in both sections have to be completed. Two exercises will be given for examination by selecting one exercise in each section. All the exercises should be given in the question paper and students are allowed to select by a lot.

Record note book should be submitted during examination.

Lathe : 45 marks (2hours)

Procedure / Preparation 10

Machining / Dimensions 25

Surface Finishing 10

Drilling : 25 marks (1 hour)

Procedure / Marking 10

Dimensions 10

Surface Finishing 5

Viva-voce : 05 marks

Total : 75 marks

LIST OF EQUIPMENT

Lathe Section

- | | | |
|---|---|---------------------|
| 1. Lathe (Minimum 4 ½') | - | 13 Nos. |
| 2. All geared lathe | - | 2 Nos. |
| 3. 4 Jaw / 3 Jaw Chucks | - | Required Numbers |
| 4. Chuck key | - | Required Numbers |
| 5. Spanner | - | Sufficient quantity |
| 6. Cutting Tools | - | Sufficient quantity |
| 7. Pitch gauge | - | 5 Nos. |
| 8. Thread gauge | - | 5 Nos. |
| 9. Vernier Caliper | - | 5 Nos. |
| 10. Snap gauges | - | Sufficient quantity |
| 11. Steel Rule (0-150) | - | Sufficient quantity |
| 12. Calipers (Inside / Outside / Jenny) | - | Sufficient quantity |
| 13. Dial Gauge with Magnetic Stand | - | Sufficient quantity |
| 14. Marking Gauge | - | Sufficient quantity |
| 15. Safety Glass | - | 15 Nos. |

Drilling Section

- | | | |
|-----------------------------|---|---------------------|
| 1. Upright drilling machine | - | 2 Nos. |
| 2. Radial drilling machine | - | 1 No. |
| 3. Drill bit & Tap set | - | Sufficient quantity |
| 4. Reaming bit | - | Sufficient quantity |
| 5. Counter sinking bit | - | Sufficient quantity |
| 6. Counter boring bit | - | Sufficient quantity |
| 7. Plug gauges | - | Sufficient quantity |
| 8. Vernier Height Gauge | - | 1 No. |
| 9. Surface plate | - | 2 Nos. |



DIRECTORATE OF TECHNICAL EDUCATION
DIPLOMA IN MECHANICAL ENGINEERING
[MTMR]

M SCHEME
2015 -2016 onwards

II YEAR
III SEMESTER

**32045 – STRENGTH OF MATERIALS AND
FLUID MECHANICS PRACTICAL**

CURRICULUM DEVELOPMENT CENTRE

M-SCHEME

(Implements from the Academic year 2015-2016 onwards)

Course Name : DIPLOMA IN MECHANICAL ENGINEERING [MTMR]
Course Code : 2022
Subject Code : 32045
Semester : III
Subject Title : STRENGTH OF MATERIALS AND FLUID MECHANICS PRACTICAL

TEACHING AND SCHEME OF EXAMINATIONS:

No. of Weeks per Semester: 15 Weeks

Subject	Instructions		Examination			
	Hours/ Week	Hours/ Semester	Marks		Duration	
Strength of Materials and Fluid Mechanics Practical	4	90	Internal Assessment	Board Examination	Total	3 Hrs
			25	75	100	

OBJECTIVES:

- Acquire skills on different types of testing methods of metals.
- Conduct material testing on elasticity, hardness, shear strength
- Determine modulus of rigidity of open spring and closed coil springs.
- Determine the co-efficient of discharge of venturimeter, orifice meter, mouth piece and orifice.
- Determine the co-efficient of friction in pipes.
- Conduct performance test on centrifugal and reciprocating pumps.
- Conduct performance test on impulse and reaction turbines.

Strength of Materials Laboratory

Exercises

1. Test on Ductile Materials:

Finding Young's Modulus of Elasticity, yield points, percentage elongation and percentage reduction in area, stress strain diagram plotting, tests on mild steel.

2. Hardness Test:

Determination of Rockwell's Hardness Number for various materials like mild steel, high carbon steel, brass, copper and aluminium.

3. Torsion test:

Torsion test on mild steel – relation between torque and angle of twist-determination of shear modulus and shear stress.

4. Impact test:

Finding the resistance of materials to impact loads by Izod test and Charpy test.

5. Tests on springs of circular section:

Determination of modulus of rigidity, strain energy, shear stress and stiffness by load deflection method (Open / Closed coil spring)

6. Shear test:

Single or double shear test on M.S. bar to finding the resistance of material to shear load.

Fluid Mechanics Laboratory

Exercises

1. Verify the Bernoulli's Theorem.
2. Determination of co-efficient of discharge of a mouth piece / orifice by variable head method.
3. Determination of co-efficient of discharge of a venturimeter / orificemeter.
4. Determination of the friction factor in a pipe.
5. Performance test on reciprocating pump / centrifugal pump and to draw the characteristics curves.
6. Performance test on impulse turbine / reaction turbine and to find out the Efficiency.

BOARD EXAMINATION

Note: All the exercises in both sections have to be completed. Two exercises will be given for examination by selecting one exercise in each section.

All the exercises should be given in the question paper and students are allowed to select by a lot.

Record note book should be submitted during examination.

Detailed allocation

Strength of material lab

Part A	-	35 marks
Observation	-	10
Tabulation / Calculation	-	20
Result / Graph	-	5

Fluid mechanics lab

Part B	-	35 marks
Observation	-	10
Tabulation / Calculation	-	20
Result / Graph	-	5
Viva-voce	-	05 marks
Total	-	75 marks

LIST OF EQUIPMENTS

1. UTM	01
2. Rockwell's Hardness Testing Machine	01
3. Torsion testing machine	01
4. Impact testing machine	01
5. Spring testing arrangements	01
6. Shear testing machine	01
7. Vernier calliper	02
8. The Bernoulli's Apparatus	01
9. An Open tank fitted with a small orifice / an external mouth piece and a collecting tank with Piezometer	01
10. A Centrifugal pump having the discharge line with venturimeter / orifice meter arrangement	01
11. An arrangement to find friction factor of pipe	01
12. A reciprocating pump with an arrangement for collecting data to find out the efficiency and plot the characteristics curves.	01
13. A centrifugal pump with an arrangement for collecting tank to find out the efficiency and plot the characteristics curves.	01
14. A impulse turbine with an arrangement for calculating data to find out the efficiency	01
15. A reaction turbine with an arrangement for collecting data to find out the efficiency	01



DIRECTORATE OF TECHNICAL EDUCATION
DIPLOMA IN MECHANICAL ENGINEERING

[MTMR]

M SCHEME

2015 -2016 onwards

www.binils.com
II YEAR
IV SEMESTER

**32037 – METROLOGY AND METALLOGRAPHY
PRACTICAL**

CURRICULUM DEVELOPMENT CENTRE

M-SCHEME

(Implements from the Academic year 2015-2016 onwards)

Course Name : DIPLOMA IN MECHANICAL ENGINEERING [MTMR]
Course Code : 2022
Subject Code : 32037
Semester : IV
Subject Title : METROLOGY & METALLOGRAPHY PRACTICAL

TEACHING AND SCHEME OF EXAMINATIONS:

No. of weeks per semester: 15 Weeks

Subject	Instructions		Examination			
	Hours/ Week	Hours/ Semester	Marks		Duration	
Metrology & Metallography Practical	4	60	Internal Assessment	Board Examination	Total	3 Hrs
			25	75	100	

OBJECTIVES:

- Familiarize about measuring techniques of Metrology instruments.
- Select the range of measuring tools.
- Obtain accurate measurements.
- Determine the least count of measuring instruments.
- Study the working principle of Microscope.
- Specimen preparation of ferrous and non-ferrous metals.
- Grinding, polishing and mounting of specimen.
- Non-destructive testing of metals for cracks.
- Crack detection – Visual inspection, Die penetration method
- Prepare the record of work for the exercises.

METROLOGY SECTION:

- Introduction to linear measurement.
- Introduction to angular measurement.
- Introduction to geometric measurements.

- Study of Least Count of measuring instruments.
- Study of accuracy of instruments and calibration of instruments.
- Study of Linear Measuring Instruments: Vernier Caliper, Micrometer, Inside Micrometer, Vernier Height gauge, Depth Gauge and Slip Gauge.
- Study of Angular Measuring Instruments – Universal Bevel Protractor, Sine Bar.
- Study of Geometric measurement - Gear tooth Vernier, Thread Micrometer.

Exercises:

1. Measure the dimensions of ground MS flat / cylindrical bush using Vernier Caliper compare with Digital / Dial Vernier Caliper.
2. Measure the diameter of a wire using micrometer and compare the result with digital micrometer
3. Measure the thickness of ground MS plates using slip gauges
4. Measure the angle of a V-block / Taper Shank of Drill / Dovetail using universal bevel protractor.
5. Measure the angle of the machined surface using sine bar with slip gauges.
6. Measure the geometrical dimensions of V-Thread using thread Vernier gauge.
7. Measure the geometrical dimensions of spur gear.

METALLOGRAPHY SECTION:

- To study the micro structure of the metals using Metallurgical Microscope.
- Determine the micro structure of the ferrous and nonferrous metals.
- Prepare the specimen to study the microstructure.
- Conduct the liquid penetration test to find the crack.
- Conduct magnetic particle test to find cracks.

Exercises:

1. Find the grain structure of the given specimen using the Metallurgical Microscope.
2. Prepare a specimen to examine the micro structure of the Ferrous and Non-ferrous metal.
3. Detect the cracks in the specimen using Visual Inspection and ring test.
4. Detect of cracks in specimen using Die penetration test.
5. Detect the cracks in specimen using Magnetic particle test.

BOARD EXAMINATION

Note: All the exercises in both sections have to be completed. Two exercises will be given for examination by selecting one exercise in each section. All the exercises should be given in the question paper and students are allowed to select by a lot.

Record note book should be submitted during examination.

Detailed allocation

Metrology Section	45
Procedure / Least Count	15
Reading / Calculation	20
Result	10
Matallography Section	25
Procedure	10
Preparation and observation	10
Result	5
Viva voce	5
Total	75

LIST OF EQUIPMENTS

1. Vernier Caliper	-	2 Nos.
2. Digital Vernier Caliper.	-	2 Nos.
3. Dial Vernier Caliper.	-	2 Nos.
4. Micrometer	-	2 Nos.
5. Digital Micrometer	-	2 Nos.
6. Slip gauges	-	2 Nos.
7. Universal bevel protractor.	-	2 Nos.
8. Sine bar	-	2 Nos.
9. Thread micrometer	-	2 Nos.
10. Surface plate	-	2 Nos.
11. Vernier height gauge	-	1No.
12. Metallurgical Microscope.	-	2 Nos.
13. Die penetration	-	2 Nos.
14. Magnetic particle test	-	1 No.
15. Abrasive belt grinder	-	1 No.
16. Polishing machine	-	1 No.
17. Mounting machine	-	1 No.
18. Specimen (Ferrous / Non-ferrous metals)	-	Sufficient quantity
19. Consumable	-	Sufficient quantity



DIRECTORATE OF TECHNICAL EDUCATION
DIPLOMA IN MECHANICAL ENGINEERING

[MTMR]

M SCHEME

2015 -2016 onwards

www.binils.com
II YEAR
IV SEMESTER

32035 – FOUNDRY AND WELDING PRACTICAL

CURRICULUM DEVELOPMENT CENTRE

M-SCHEME

(Implements from the Academic year 2015-2016 onwards)

Course Name : DIPLOMA IN MECHANICAL ENGINEERING [MTMR]
Course Code : 2022
Subject Code : 32035
Semester : IV
Subject Title : FOUNDRY AND WELDING PRACTICAL

TEACHING AND SCHEME OF EXAMINATIONS:

No. of weeks per semester: 15 Weeks

Subject	Instructions		Examination			
	Hours/ Week	Hours/ Semester	Marks		Duration	
Foundry and Welding Practical	4	60	Internal Assessment	Board Examination	Total	3 Hrs
			25	75	100	

OBJECTIVES:

- Identify the tools used in foundry.
- Identify the tools and equipment used in welding
- Prepare sand moulds for different patterns.
- Perform welding operation to make different types of joints.
- Identify the different welding defects.
- Appreciate the safety practices used in welding.
- Prepare a record of work for all the exercises.

Foundry Section

1. Introduction of tools and equipment
2. Types of patterns
3. Types of sand
4. Preparation of sand moulds
5. Core sands, preparation of cores

Exercises:

Prepare the green sand mould using the following patterns.

Solid pattern

1. Stepped pulley

Split pattern

2. Bent Pipe with core print
3. T-pipes with core print
4. Tumbles

Loose Piece Pattern

5. Dovetail

Core preparation

6. Core preparation for Bent pipe / T-pipe

Welding Section

1. Introduction of Safety in welding shop
2. Introduction to hand tools and equipment
3. Arc and gas welding equipment
4. Types of joints

Exercises :

Make the following welding joint / cutting.

Arc welding (Raw Material: 25 mm x 6mm MS flat)

1. Lap joint
2. Butt joint
3. T- joint

Gas Welding (Raw Material: 25mm x 3mm Ms flat)

4. Lap joint

Gas cutting: (GI/MS Sheet - 3mm thickness)

5. Profile cutting – circular profile

Spot welding: (GI/MS Sheet)

6. Lap joint

BOARD EXAMINATION

Note: All the exercises in both sections have to be completed. Two exercises will be given for examination by selecting one exercise in each section.

All the exercises should be given in the question paper and students are allowed to select by a lot.

Record note book should be submitted during examination.

Detailed allocation

Foundry		: 35 marks
Preparation of sand	- 10	
Ramming and vent holes	- 15	
Gate cutting / Finish	- 10	
Welding		: 35 marks
Edge preparation	- 10	
Welding / Cutting	- 15	
Joint strength / Finish	- 10	
Viva-voce		: 05 marks
Total		: 75 marks

LIST OF EQUIPMENT

Welding:

1. Arc welding booth	-	2 No's with welding transformer
2. Gas welding unit	-	1 Set (Oxygen and acetylene cylinder)
3. Flux	-	Sufficient quantity
4. Electrode	-	Sufficient quantity
5. Welding rod	-	Sufficient quantity
6. Welding shield	-	5 Nos.
7. Gas welding goggles	-	5 Nos.
8. Leather Glows 18"	-	10 Sets.
9. Chipping hammer	-	10 Nos.
10. Spot welding machine	-	1 No.
11. Personal protective equipment	-	Sufficient quantity
12. Fire safety equipment	-	Sufficient quantity

Foundry:

1. Moulding board	-	15 Nos.
2. Cope box	-	15 Nos.
3. Drag box	-	15 Nos.
4. Core box	-	10 Nos.
5. Shovel	-	5 Nos.
6. Rammer set	-	15 Nos.
7. Slick	-	15 Nos.
8. Strike-off bar	-	15 Nos.
9. Riddle	-	5 Nos.
10. Trowel	-	15 Nos.
11. Lifter	-	15 Nos.
12. Cleaning Brush	-	20 Nos.
13. Vent rod	-	15 Nos.
14. Draw spike	-	15 Nos.
15. Gate cutter	-	15 Nos.
16. Runner & riser	-	15 Nos. each
17. Patterns	-	Sufficient quantity

39291 - Industrial Training – I (Report Writing & Viva Voce)

www.binils.com



DIRECTORATE OF TECHNICAL EDUCATION

**DIPLOMA IN MECHANICAL ENGINEERING (MACHINE TOOL MAINTENANCE
AND REPAIRS) (SANDWICH)**

III YEAR

M – SCHEME

V SEMESTER

2015 -2016 onwards

www.binils.com

39251

INDUSTRIAL PRODUCTION TECHNOLOGY – II

CURRICULUM DEVELOPMENT CENTRE

M-SCHEME

(Implements from the Academic year 2015-2016 onwards)

Course Name: DIPLOMA IN MECHANICAL ENGINEERING (Machine Tool

Maintenance and Repairs)

Course Code: 2022

Subject Code: 39251

Semester: V

Subject Title: INDUSTRIAL PRODUCTION TECHNOLOGY – II

Subject	Instructions		Examination			
	Hours / Week	Hours /Semester	Marks		Duration	
INDUSTRIAL PRODUCTION TECHNOLOGY – II	4	60	Internal Assessment	Board Examination	Total	3 Hrs
			25	75	100	

Topics and Allocation of Hours:

S.No	Topic	Hours
1	Theory of Metal cutting, Drilling machines and Boring Machines	11
2	Reciprocating Machines	11
3	Milling machines and gear generating processes	11
4	Abrasive Process and Broaching	11
5	Jigs & Fixtures & Non-Conventional Machining	11
6	Test and Revision	5
	Total	60

Rational:

It is pertinent that those involved in the process of manufacturing should possess adequate and thorough knowledge about the working of conventional as well as non conventional machines to see that the process of manufacturing goes on without any hindrance. This will

help the individuals to hasten and also troubleshoot the hiccups that may crop up in the process of manufacturing.

Objectives:

- To know the Theory of Metal cutting, Drilling machines and Boring Machines
- To know about Reciprocating Machines
- To know about Milling machines and gear generating processes
- To know about Abrasive Process and Broaching
- To know about Jigs & Fixtures & Non-Conventional Machining

INDUSTRIAL PRODUCTION TECHNOLOGY – II
Detailed Syllabus

Unit	Name of the Topic	Hours
I	<p>THEORY OF METAL CUTTING, DRILLING MACHINES AND BORING MACHINES</p> <p>Theory of Metal Cutting: Cutting tool material-High carbon Steel-High Speed Steel-Stellites-Cemented carbides-ceramics-Composition and applications for the above.</p> <p>Drilling Machines: Drills-flat drills-twist drills-types of drilling machines-bench type-floor type-radial type-gang drill-multi spindle type-principle of operation in drilling-speeds and feeds for various materials-drilling holes-methods of holding drill bit-drill chucks-socket and sleeve-drilling-operation-reaming-counter sinking-counter boring-spot facing-tapping-deep hole drilling.</p> <p>Boring Machines: Boring machines-horizontal and vertical types-fine boring machines-boring tools</p>	11
II	<p>RECIPROCATING MACHINES</p> <p>Planer: Types of planers-description of double housing planer specifications- principles of operation-drives-quick return mechanism-feed mechanism- work holding devices and special fixtures-types of tools various operation.</p> <p>Shaper: Types of shapers-specifications-standard-plain-</p>	11

	<p>universal principles of operations-drives-quick return mechanism-crank and slotted link-feed mechanism-work holding devices-Special fixture-various operations.</p> <p>Slotter: Types of slotters-specifications-method of operation-Whitworth quick return Mechanism-feed mechanism-work holding devices-types of tools.</p>	
III	<p>MILLING MACHINES AND GEAR GENERATING PROCESSES</p> <p>Milling Machines: Types-column and knee type-plain-universal milling machine-vertical milling machine-specification of milling machines principles of operation-work and tool holding devices-arbor-stub arbor spring collect-adapter-milling cutters-cylindrical milling cutter-slitting cutter side milling cutter-angle milling cutter-T-slot milling cutter-woodruff milling cutter-fly cutter-milling process conventional milling-climb milling-milling operations-straddle milling-gang milling-vertical milling attachment.</p> <p>Generating Process: gear shaper - gear hobbing - principle of operation only - gear finishing processes-burnishing-shaving-grinding and lapping gear materials - cast iron, steel, alloy steels, brass, bronze, aluminum and nylon.</p>	11
IV	<p>ABRASIVE PROCESS AND BROACHING</p> <p>Abrasive Process: Types and classification-specifications-rough grinding – pedestal grinders- portable grinders- belt grinders-precision grinding cylindrical grinder- center less grinders – surface grinder- tool and cutter grinder - planetary grinders-principles of operations-grinding wheels abrasives-natural and artificial diamond wheels -mounting of grinding wheels-Dressing and Truing of wheels-Balancing of grinding wheels.</p> <p>Broaching: Types of broaching machine - horizontal, vertical and continuous broaching - principles of operation - types of broaches classification - broach tool nomenclature - broaching</p>	11

	operations - simple examples	
V	<p>JIGS & FIXTURES& NON-CONVENTIONAL MACHINING</p> <p>Jigs And Fixtures: Definitions and concept of Jig and fixture- Advantages of jigs and fixtures-elements of jigs and fixtures- locating devices-'V' locators-fixed stop locators-adjustable stop locators-clamping devices strap clamp, screw clamp-cam action clamp-types of jigs-box drill jig indexing drill jig-types of fixtures-keyway milling fixture-string milling fixture.</p> <p>Non-Conventional Machining Processes: Construction, working and applications of Ultrasonic machining-chemical machining-electro chemical grinding-electrical discharge machining-plasma arc machining-LASER machining- Advantages – Disadvantages.</p>	11

Text Book : 1) Elements of Workshop Technology- Vol. I & II, HajraChoudry&Battacharya, ,Edn. 11, published by Media Promoters and Publishers Pvt. Ltd., Seervai Buildings `B', 20-G, NoshirBharuchaMarg, Mumbai 400 007 – 2007.

2) Production Technology, Jain & Gupta, ,Khanna Publishers, 2-B, North Market, Naisarak, New Delhi – 110 006 – 2006.

Reference Book :

1) Production Technology, HMT, ,Edn. 18, published by Tata McGraw Hill Publishing Co. Ltd., 7, West Patel Nagar, New Delhi 110 008.

2) Manufacturing process, Myro N Begman, ,Edn. 5, Tata McGraw Hill Publishing Co. Ltd., 7, West Patel Nagar, New Delhi 110 008.

3) Workshop Tech Vol I,II, III, WAJ. Chapman, published by Viva Books Pvt. Ltd., 4262/3, Ansari Road, Daryaganj, New Delhi 110 002.

4) Production processes, NITTTR, published by 5, Tata McGraw Hill Publishing Co.



DIRECTORATE OF TECHNICAL EDUCATION

**DIPLOMA IN MECHANICAL ENGINEERING (MACHINE TOOL MAINTENANCE
AND REPAIRS) (SANDWICH)**

II YEAR / III YEAR

M – SCHEME

V SEMESTER

2015 -2016 onwards

www.binitis.com

39252

THERMAL AND RENEWABLE ENERGY

CURRICULUM DEVELOPMENT CENTRE

M-SCHEME

(Implements from the Academic year 2015-2016 onwards)

Course Name: DIPLOMA IN MECHANICAL ENGINEERING (Machine Tool

Maintenance and Repairs)

Course Code: 2022

Subject Code: 39252

Semester: V

Subject Title: Thermal and Renewable Energy

Subject	Instructions		Examination			
	Hours / Week	Hours /Semester	Marks		Duration	
Thermal and Renewable Energy	4	60	Internal Assessment	Board Examination	Total	3 Hrs
			25	75	100	

Topics and Allocation of Hours:

S.No	Topic	Hours
1	Basics of Thermodynamics and IC Engines	11
2	Steam Boilers, Boiler Mountings, Boiler Accessories, Thermal Power Plants	11
3	Refrigeration, Psychrometry, Air Conditioning	11
4	Fundamentals of Energy, Solar Energy	11
5	Wind Energy, Bio – Energy	11
6	Test	5
	Total	60

RATIONALE: The exponential growth of engineering industries has made a wide scope for maintenance engineering. The student studying maintenance should have a thorough knowledge in various aspects of Thermal Equipment and Energy Conservation.

Objectives :

- To know about Basics of Thermodynamics and IC Engines
- To know about Steam Boilers, Boiler Mountings, Boiler Accessories, Thermal Power Plants
- To know about Refrigeration, Psychrometry, Air Conditioning

- To know about Fundamentals of Energy, Solar Energy
- To know about Wind Energy, Bio – Energy

Thermal and Renewable Energy

Detailed Syllabus

Unit	Name of the Topic	Hours
I	<p>Basics of Thermodynamics and IC Engines</p> <p>Introduction – definition and units of mass, weight, volume, density, specific weight – gravity – pressure – units - atmospheric, gauge, vacuum and absolute pressure - temperature - Celsius and absolute temperature - S.T.P and N.T.P conditions - heat - specific heat capacity at constant volume and at constant pressure - work - power - energy - types - thermodynamic system - types -properties and state of system - intensive and extensive properties -thermodynamic process - cycle - point and path function - law of conservation of energy - equilibrium - thermodynamic - zeroth , first and second law of thermodynamics- Perfect gases - law of perfect gases - Boyle's, Charles', Joule's, Regnault's and Avogadro's law - characteristic gas equation – relation between specific heats and gas constant - universal gas constant .</p> <p>Introduction - classifications -four stroke cycle petrol and diesel engines -merits and demerits - two stroke cycle petrol and diesel engines – comparison constructional details of I.C.engine -components of engines – cylinder block, crankcase, cylinder head, liners, oil pan, piston, piston rings, connecting rod, crank shaft, cam shaft, valve and valve train - material and manufacturing methods - valve timing diagram for four stroke petrol and diesel engines – port timing for four stroke petrol and diesel engines Layout of fuel supply system in petrol engines</p>	11
II	<p>Steam Boilers, Boiler Mountings, Boiler Accessories, Thermal Power Plants</p> <p>Introduction – formation of steam – condition of steam – wet,</p>	11

	dry and superheated steam – dryness fraction – classification of boilers – high pressure boilers – Lamont and BHEL high pressure boilers – advantages of high pressure boilers – boilers mountings – function – construction and working – boilers accessories – function – construction and working comparison of mountings and accessories Layout of thermal power plant – fuel and ash circuit – water and steam circuit –air and flue gas circuit – cooling water circuit – merits and demerits of thermal power plant – selection site for thermal power plant – air pollution by thermal power plant – pollutants and effect of pollution – pollution control.	
III	Refrigeration, Psychrometry, Air Conditioning Refrigeration – refrigerators – types and application of refrigeration – vapour compression refrigeration system – vapourabsorption system – comparison – refrigerating effect – capacity of refrigerating unit – COP – actual COP – power required – no problems. Air-conditioning – psychometric properties – dry air – moist air – water vapour –saturated air – dry bulb temperature – wet bulb temperature – wet bulb depression – dew point temperature – humidity – specific and relative humidity –psychometric chart – psychometric process – sensible heating and cooling – humidification- dehumidification – cooling and dehumidification	11
IV	FUNDAMENTALS OF ENERGY, SOLAR ENERGY Introduction to Energy-Energy consumption and standard of living-classification of energy resources-consumption trend of primary energy resources-importance of renewable energy sources SOLAR ENERGY Introduction – Solar radiation at the earth's surface-Solar Radiation measurements-Estimation of average solar Radiation. Solar energy collectors- Classifications-Flat plate collectors-Concentrating collectors-Comparison. Solar water	11

	heaters-Solar industrial heating system Principles of photovoltaic conversion of solar energy – types of solar cells – solar Photo Voltaic applications	
V	<p>WIND ENERGY, BIO – ENERGY</p> <p>Introduction-Basic principles of wind energy conversion:-site selection-classification of wind energy conversion systems-Advantages and Disadvantages-Types of wind machines-Horizontal axis machine-Vertical axis machine-Generating system-Energy Storage–Application of wind energy-Safety and environmental aspects.</p> <p>Introduction – usable forms of bio mass, their composition and fuel properties-Biomass resources– Biogas production from waste Biomass – types of bio gas plants - applications – Biomass energy programmed in India.</p>	11

Text Book :

1. A Textbook Of Thermal Engineering by R.S Kurmi -- S. Chand, 01-2008
2. Non-conventional energy sources – G.D.Rai - Khanna, 1997
- 3) Non Conventional Energy Sources and Utilisation - R.K. Rajput - S.Chand& Company Ltd., 2012.

Reference Books

- 1) Renewable Energy Sources - Twidell, J.W. and Weir, A. - EFN Spon Ltd., 1986.
- 2) "Non-Conventional Energy Resources - B.H.Khan - Tata McGraw Hill, 2nd Edn, 2009.



DIRECTORATE OF TECHNICAL EDUCATION

**DIPLOMA IN MECHANICAL ENGINEERING (MACHINE TOOL MAINTENANCE
AND REPAIRS) (SANDWICH)**

II YEAR / III YEAR

M – SCHEME

V SEMESTER

2015 -2016 onwards

www.birnils.com

39253

ENGINEERING METROLOGY

CURRICULUM DEVELOPMENT CENTRE

M-SCHEME

(Implements from the Academic year 2015-2016 onwards)

Course Name: DIPLOMA IN MECHANICAL ENGINEERING (Machine Tool

Maintenance and Repairs)

Course Code: 2022

Subject Code: 39253

Semester: V

Subject Title: ENGINEERING METROLOGY

Subject	Instructions		Examination			Duration
	Hours / Week	Hours /Semester	Marks			
Engineering Metrology	4	60	Internal Assessment	Board Examination	Total	3 Hrs
			25	75	100	

Topics and Allocation of Hours:

S.No	Topic	Hours
1	Limits, Fits And Gauges:	11
2	Straightness, Flatness, Squareness, Parallelism, Circularity And Rotation	11
3	Angular Measurement And Surface Finish	11
4	Comparators And Non Destructive Testing	11
5	Transducers	11
6	Test and Revision	6
	Total	60

RATIONALE:

The exponential growth of engineering industries has made a wide scope for maintenance engineering. The student studying maintenance should have a thorough knowledge in various aspects of Metrology

Objectives:

- To know the Limits, Fits And Gauges:
- To know the Straightness, Flatness, Squareness, Parallelism, Circularity And Rotation
- To know about Angular Measurement And Surface Finish

- To know about Comparators And Non Destructive Testing
- To about Transducers

Engineering Metrology

Detailed Syllabus

Unit	Name of the Topic	Hours
I	<p>LIMITS, FITS AND GAUGES:</p> <p>Introduction – Tolerance – Importance of Tolerance – different ways of expressing tolerance – interchangeability – selective assembly – Indian standards – definitions – fits – sizes – deviation tolerance – clearance – interference – guide for selection of fits – clearance fits – transmission fits –interference fits – ISO system of limits and fits – gauges – types of gauges – limit gauges – plug gauges – ring gauges – snap gauges – gauges for taper – adjustable type gap gauges – miscellaneous gauges – geometric characteristics and symbols</p>	11
II	<p>STRAIGHTNESS, FLATNESS, SQUARENESS, PARALLELISM, CIRCULARITY AND ROTATION:</p> <p style="text-align: center;">Straightness-</p> <p>definitions - straight edge- tests for straightness by using spirit level - auto collimator - flatness testing- procedure. Parallelism- two axis - two planes- parallel motion between trajectory and plane – trajectory to an axis two trajectories - equidistance- coincidence or alignment. Square ness - axis of rotation with a given plane - perpendicularity of motion- square ness testing - indicator method- correction for square ness error - engineer's square tester- optical tester for square ness – Optical test for square ness – Circularity – sources of out of roundness – different types of irregularities of a circular part – causes of out of roundness – roundness and circularity – measurement of roundness by using V block – Test for checking rotation – run out</p>	11
III	<p>ANGULAR MEASUREMENT AND SURFACE FINISH:</p>	11

	<p>Instruments for angular measurement- venire and optical level protractor- universal bevel protractors optical dividing head- angle gauges- use of angle gauges- manufacture of angle gauges- spirit level clinometers - auto collimator- photo electric micro tic auto collimator- automatic position sensing auto collimator- angle Decker- uses of angle Decker in combination with angle gauges.</p> <p>Surface finish: surface texture- surface roughness- terminology as per Indian standard- methods of measuring surface finish- touch inspection- visual- scratch- microscopic- photographs- micro interferometer- Wallace surface dynamometer- reflected light intensity- direct instruments- stylus probe instruments - profilometer- replica method- sample length- analysis of surface traces- maximum peak of valley height of roughness-RMS meaning- Indian standard- measurement of surface finish- pneumatic methods of a valuating surface finish- tracer type profilogram- light cross section method</p>	
IV	<p>Comparators And Non Destructive Testing</p> <p>Introduction – Need for comparator – Principal of operation – Characteristics of good comparator – Classification – Mechanical Comparator – optical comparator – Electronic comparator – Pneumatic comparator</p> <p>Introduction – Commonly used Non destructive testing – Visual inspection – Pressure and leak test – Dye penetrant – Ultrasonic test – Radiography – Magnetic Particle testing – eddy current testing</p>	11
V	<p>TRANSDUCERS:</p> <p>Transducers element- mechanical- springs- bourdon tube – diaphragm – capsule – bellows – Introduction to Analog transducer – Potentiometric resistance type transducer – inductive type transducer – self generating types – non –self</p>	11

	<p>generating types – capacitive type transducer – piezo electric – dynamic characteristics of piezo – electric transducer – resistance strain gauge – unbounded and bonded strain gauge – ionization – mechano-electric transducer – opto-electrical transducer-photo emissive transducer – photo conductive – photo voltaic transducer – Digital transducer – frequency domain transducer – electromagnetic frequency domain – opto-electric frequency domain – vibrating string transducer – digital encoders. Amplifiers – mechanical amplifying element – hydraulic amplifying element – pneumatic amplifying element – optical amplifying element – Electrical amplifying elements</p>	
--	--	--

Text Book:

1. Engineering Metrology by R.K.Jain, Khanna Publishers 1994

Reference Books :

1. M.Mahajan, "A text-Book of Metrology", Dhanpat Rai & Co.
2. A Textbook of Engineering Metrology (English) 7th Edition by Gupta,



DIRECTORATE OF TECHNICAL EDUCATION

**DIPLOMA IN MECHANICAL ENGINEERING (MACHINE TOOL MAINTENANCE
AND REPAIRS) (SANDWICH)**

III YEAR

M – SCHEME

V SEMESTER

2015 -2016 onwards

www.binils.com

39254

MAINTENANCE OF MACHINE DRIVE ELEMENTS

CURRICULUM DEVELOPMENT CENTRE

M-SCHEME

(Implements from the Academic year 2015-2016 onwards)

Course Name : DIPLOMA IN MECHANICAL ENGINEERING (Machine Tool

Maintenance and Repairs)

Course Code : 2022

Subject Code : 39254

Semester : V

Subject Title : Maintenance of Machine Drive Elements

Subject	Instructions		Examination			Duration
	Hours / Week	Hours /Semester	Marks			
Maintenance of Machine Drive Elements	4	60	Internal Assessment	Board Examination	Total	3 Hrs
			25	75	100	

Topics and Allocation of Hours:

S.No	Topic	Hours
1	Friction and antifriction bearings	11
2	Belt drives and chain drives	11
3	Belt drives and chain drives	11
4	Clutches, brakes and couplings	11
5	Maintenance of mechanisms and safety devices	11
6	Test and Revision	5
	Total	60

RATIONALE:

The exponential growth of engineering industries has made a wide scope for maintenance engineering. The student studying maintenance should have a thorough knowledge in maintenance of Bearings, clutches, Compressors, Transmission systems, I.C engines, R& Ac Equipments and safety in industries.

Objectives:

- To about Friction and antifriction bearings
- To about Belt drives and chain drives
- To about Belt drives and chain drives

- To about Clutches, brakes and couplings
- To about Maintenance of mechanisms and safety devices

Maintenance of Machine Drive Elements Detailed Syllabus

Unit	Name of the Topic	Hours
I	<p>FRICITION AND ANTIFRICITION BEARINGS,</p> <p>a) Bearings: Types of bearings- friction bearings-solid and splited type friction bearings - regulated type and non regulated type- repair of bush bearings- – reconditioning.-pouring stellon compound- casting method- reboring- lubrication of friction bearings.- defects in friction bearings and rectification-</p> <p>b)Anti friction bearings- ball, roller and taper roller bearings-special types of bearings-Bearing designation-bearing failure analysis-</p> <p>Care and maintenance – bearing inspection and examination – lubrication of antifricition bearings- grease Vs oil comparison - bearing removal and assembly – tools and equipments used hydraulic press -bearing puller</p>	11
II	<p>BELT DRIVES AND CHAINDRIVES;</p> <p>a) Bet drives: Types of belt and pulley- flat belt, V belt ,rope belt and timing belt. Flat belt pulley, V pulley and geared tooth pulley.</p> <p>b)Care and maintenance of flat leather belt – care and maintenance of rubber V-belts – belt fastening –</p> <p>c) Aligning of shaft and pulleys – installation and removal procedure for pulley and belts- straight edge and try square method- straight edge and slip gauge method- belt and pulley trouble shooting – mechanism for belt tensioning.</p> <p>d) Chain drives: Types of chain drives-silent chain and roller chain-</p> <p>Installation of chain drives – maintenance of precision chain</p>	11

	drives –lubrication of chain drives- care of sprockets.	
III	<p>POWER TRANSMISSION GEAR DRIVE SYSTEMS:</p> <p>a) Gear drives: types of gears and its uses and application. Simple and compound gear drive-types of gear drives and its importance of drive transmission</p> <p>b) Installation and alignment of gear drives</p> <p>c) Maintenance and troubleshooting – lubrication of gear drives- gear defects and general repairs</p>	11
IV	<p>CLUTCHES, BRAKES AND COUPLINGS:</p> <p>a) Clutches; Types of clutches – clutch installation – care and maintenance of clutches –lubrication of clutches drives- general repairs.</p> <p>b) Brakes; Types of brakes – shoe brake, band brake ,and disc brake, air and oil brake- electromagnetic multiple disc friction brake-installation – care and maintenance of brakes – general repairs.</p> <p>c) Types of couplings – general causes of coupling failure – parallel and angular misalignment of couplings.</p>	11
V	<p>MAINTENANCE OF MECHANISMS AND SAFETY DEVICES:</p> <p>a) Mechanical: Lead screw and nut mechanism, cam and follower ,crank and connecting rod mechanism, pivots and lever mechanism, quick return mechanism in shaping machine and planning machine ,PIV drives using belt , chain and disc drives-mechanical stroke limiter. Care and Replacement of Seals used in hydraulic and pneumatic components and engine head assembly .</p> <p>b) Electrical elements;- limit switch , push buttons ,relays and contactors and proximity sensor both magnetic ,inductive and capacitive sensor.</p> <p>c) Pneumatic and Hydraulic drives;-pressure switch-quick return mechanism in shaping machine.</p>	11

	d) Safety devices; Shear pin, interlocking devices, slipping dog clutch, unidirectional clutch,.Dripping relay switch for electrical heaters and motors	
--	---	--

TEXT BOOK

1. Maintenance Engineering Hand book by L.C. Morrow
2. Industrial Maintenance by H.P. Garg – chand& Co

REFERENCE BOOKS:

1. Material Handling Equipment by Alexandrov –MIR Pubs.
2. Mechanical Equipment Maintenance – ITB Manual

www.binils.com



DIRECTORATE OF TECHNICAL EDUCATION
DIPLOMA IN MECHANICAL ENGINEERING

M SCHEME
2015 -2016 onwards

III YEAR
V SEMESTER

www.binils.com

32044 – ELECTRICAL DRIVES AND CONTROL

CURRICULUM DEVELOPMENT CENTRE

M-SCHEME

(Implements from the Academic year 2015-2016 onwards)

Course Name : DIPLOMA IN MECHANICAL ENGINEERING [MTMR]
Course Code : 2022
Subject Code : 32044
Semester : V
Subject Title : ELECTRICAL DRIVES AND CONTROL

TEACHING AND SCHEME OF EXAMINATIONS:

No. of Weeks per Semester: 15 Weeks

Subject	Instructions		Examination			
	Hours /Week	Hours/ Semester	Marks		Duration	
Electrical Drives and Control	6	90	Internal Assessment	Board Examination	Total	3 Hrs
			25	75	100	

Topics and Allocation of Hours:

Unit	Topics	Hours
I	DC CIRCUITS AND DC MACHINES	17
II	AC CIRCUITS AND AC MACHINES	17
III	STEPPER AND SERVO MOTORS & DRIVES	17
IV	POWER SUPPLIES AND LOGIC GATES	16
V	CONTROL ELEMENTS AND PLC	16
	TEST AND REVISION	7
	Total	90

RATIONALE:

The automation is being the order of the day to improve the production with high quality consciousness. Such automation involves electrically operated switches,

sensors controlled through electrically driven motors and actuators. The subject aims in introducing the basic electrical DC and AC circuits and motors and also focuses on the various special control devices like stepper, servo drives and its controlling elements.

OBJECTIVES:

- Explore fundamental electric circuit laws.
- Explain the working principle of DC and AC Electrical machines.
- Identify the effective uses of drives of Electrical machines.
- Analyze the various power supply circuits.
- Select the field controlled elements.
- Explain the construction and working of Transformer.
- Compare the different types of Logic gates.
- Appreciate the safety practices followed in Electrical system.
- Compare the use of servo motors and stepper motors in electrical driving system
- Identify PLC Input outputs.
- Identify the use of Control elements.

**ELECTRICAL DRIVES & CONTROL
DETAILED SYLLABUS**

Contents: Theory

Unit	Name of the Topic	Hours
I	DC CIRCUITS AND DC MACHINES Definition- Electric current, voltage and resistance -Ohm’s law and Kirchoff’s law. Resistance in series and parallel and series, parallel – simple problems electromagnetism(definitions only) – magnetic flux, flux density magnetic field intensity, MMF, permeability, reluctance, Faraday’s law of electromagnetic induction, electrical and mechanical units DC generators – construction, principle of operation, types and application. DC motors: - construction, principle of operation, types and	17

application.

Necessity of starters: Three point, four point starters.

II AC CIRCUITS AND AC MACHINES

17

Fundamentals of AC voltage, and current – peak, average, RMS value of sine wave, frequency, time period, amplitude, power and power factor (definition only)- star and delta connection relationship between phase, line voltage and current in star and delta connections.

Transformer: Principle of operation and construction – EMF equation (no definition)- losses in Transformer – efficiency – application.

Alternator construction – principle of operation – types and applications.

AC machine: AC motors- Principle of operation of single phase capacitor start and universal motor induction motor- applications- Three phase induction motors – Squirrel cage and slip ring Induction motors (construction and working principle only) - application – speed control of 3 Φ Induction motor -Necessity of starters – DOL and star/delta starter.

III STEPPER AND SERVO MOTORS & DRIVES:

17

PMDC, Stepper motor- construction and working principle and applications - Servo motor – types: brushless servo motor, permanent magnet servo motor construction and applications.

Industrial drives- types, group drive, individual drive, multi motor drive, block diagram of Variable frequency drive , stepper motor drive: single stepping and half stepping. Servo drives.

Electrical safety: - importance of earthing - electric shock: first aid, precautions - causes of accident and their preventive measures.

Energy conservation

IV POWER SUPPLIES AND LOGIC GATES

16

Diode – terminals: anode and cathode, forward biasing and reverse biasing – use of diode in rectifiers – half wave and full wave – necessity of filters- Regulated power supplies: IC voltage regulators – SMPS, UPS and Inverters – General description and their

applications.

Display devices – LED, 7 segment LED, LCD

Logic gates: Positive and negative logic, definition, symbol truth table, Boolean expression for OR, AND, NOT, NOR, NAND, EXOR AND EXNOR gates – Universal logic Gates: NAND, and NOR.

V CONTROL ELEMENTS AND PLC

16

Fuses – selection of fuse – necessity of fuse- fuse switch units.

Sensors: Photo electric sensor, Inductive proximity sensors, Temperature sensors.

Switches: Push button switch, selector switch, limit switch, pressure switch,

temperature switch, float switch and reed switch.

Relays – NO, NC – usage- bimetallic thermal overload relays.

Contactors- usage – necessity of contactor- Solenoid type contactor

Circuit breakers – Miniature case Circuit breaker (MCCB) and Miniature Circuit

breaker (MCB), Oil Circuit breakers (OCB), Earth leakage circuit breaker (ELCB)

Features of PLC-PLC Block diagram- PLC scan - Fixed and modular PLC Ladder logic-NO, NC contacts-Coils-AND, OR.

Text Books:

- 1) A course in electrical engineering - B.L.Theraja - Multi Colour Edition, S Chand & Co, Reprint 2006
- 2) Control of Machines - S.K Bhattacharya, Brijinder Singh – New Age Publishers, Second Edition- Reprint 2010
- 3) Electronic Circuits & System- Analog and Digital – Y.N.Bapat - Tata Mc Graw Hill.

Reference Books:

- 1) Electrical Technology – Hughes - 8th Edition, Pearson Education.
- 2) Electronic Device and Circuits- An introduction – Allen Mottershed - Prentice Hall of India.



DIRECTORATE OF TECHNICAL EDUCATION
DIPLOMA IN MECHANICAL ENGINEERING

M SCHEME

2015 -2016 onwards

www.binils.com
III YEAR
V SEMESTER

32046 – SPECIAL MACHINES PRACTICAL

CURRICULUM DEVELOPMENT CENTRE

M-SCHEME

(Implements from the Academic year 2015-2016 onwards)

Course Name : **DIPLOMA IN MECHANICAL ENGINEERING [MTMR]**
Course Code : **2022**
Subject Code : **32046**
Semester : **V**
Subject Title : **SPECIAL MACHINES PRACTICAL**

TEACHING AND SCHEME OF EXAMINATIONS:

No. of weeks per semester: 15 Weeks

Subject	Instructions		Examination			Duration
	Hours /Week	Hours/ Semester	Marks			
Special Machines Practice	4	60	Internal Assessment	Board Examination	Total	3 Hrs
			25	75	100	

OBJECTIVES:

- Identify a milling machine and its parts
- Identify a cylindrical grinder, surface grinder and tool and cutter grinder
- Identify shaper, Slotter and its parts
- Identify the tools and instruments used in milling.
- Handle the different types of work holding devices
- Machine a component using different machine tools.
- Calculate the indexing for a work
- Machine a gear using milling machine.
- Machine a cutting tool using Tool and Cutter grinder.
- Machine a plug gauge using Cylindrical grinding machine.
- Machine components by shaping machine
- Machine components by slotting machine
- Prepare a record of work for all the exercises.

EXERCISES:

Raw Material: M.S. / C.I

1. Make 'V' Block using shaping machine

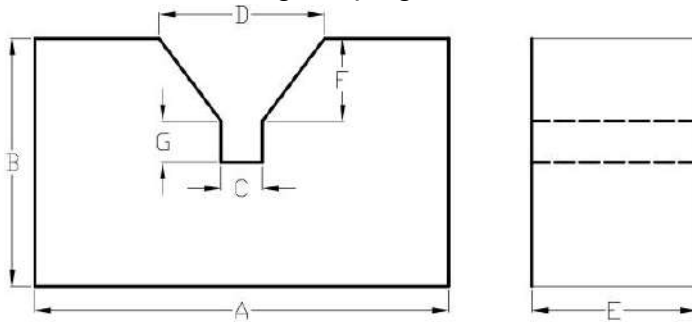

Dimensions			
Sl.No	Part Name	Actual	Obtained

2. Make dovetail using shaping machine

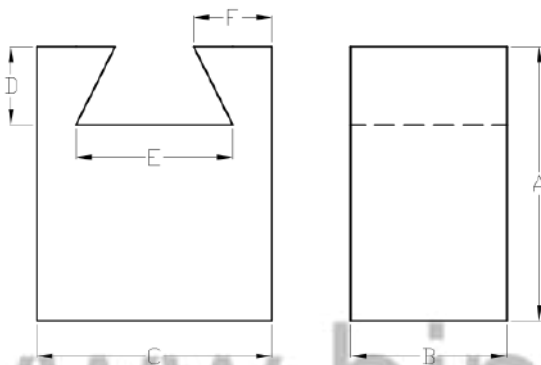

Dimensions			
Sl.No	Part Name	Actual	Obtained

3. Make groove cut using slotting machine

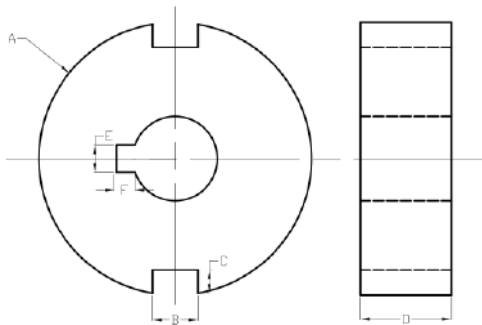

Dimensions			
Sl.No	Part Name	Actual	Obtained

4. Make round to square in milling machine.

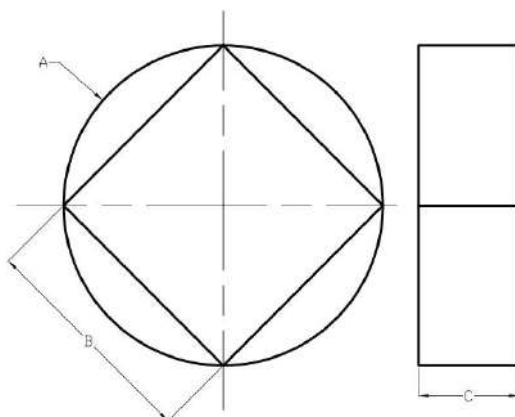

Dimensions			
Sl.No	Part Name	Actual	Obtained

5. Make Spur Gear using milling machine by Differential Indexing.

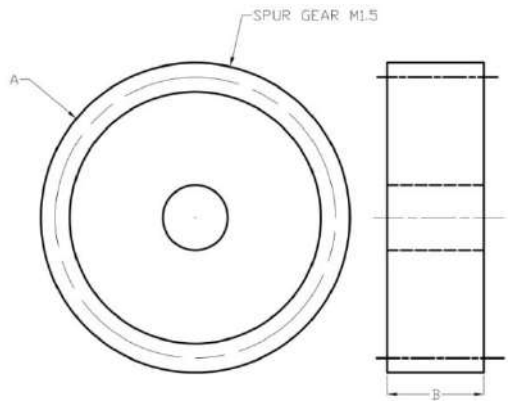

Dimensions			
Sl.No	Part Name	Actual	Obtained

6. Make Helical Gear using milling machine

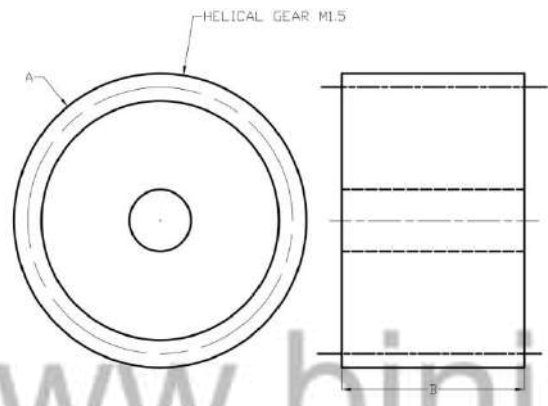

Dimensions			
Sl.No	Part Name	Actual	Obtained

7. Make slot cut using milling machine.

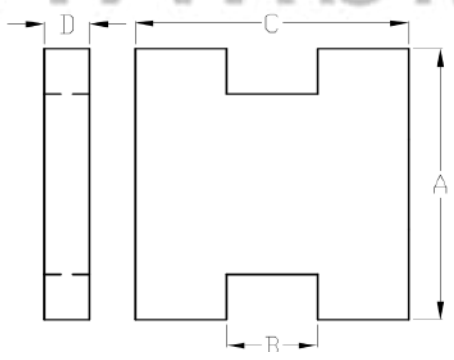

Dimensions			
Sl.No	Part Name	Actual	Obtained

8. Make Progressive type Plug gauge using Cylindrical Grinding machine

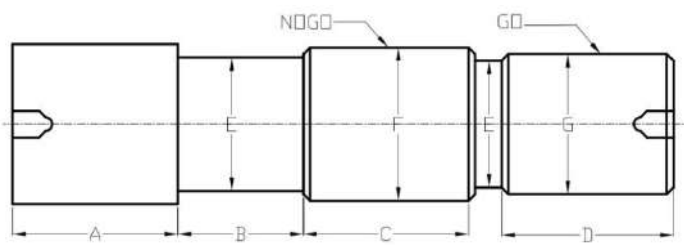

Dimensions			
Sl.No	Part Name	Actual	Obtained

9. Make a turning tool using Tool and Cutter Grinder

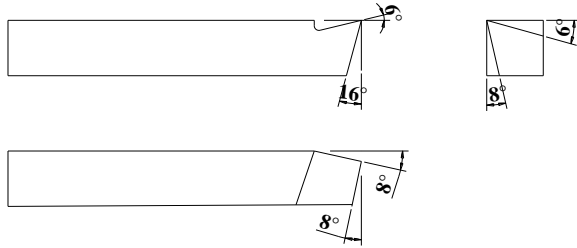

Dimensions			
Sl.No	Part Name	Actual	Obtained

10. Make plain surfaces (four surfaces) using surface Grinder



Dimensions			
Sl.No	Part Name	Actual	Obtained

www.binils.com

BOARD EXAMINATION

Note: All the exercises should be given in the question paper and students are allowed to select by a lot. Record note book must be submitted for the examination.

ALLOCATION OF MARKS

Job preparation / Marking	15
Setting / Operations	30
Dimensions / Surface Finish	25
Viva voce	5
Total	75

LIST OF EQUIPMENTS

1. Vertical milling machine /
Vertical attachment - 2 Nos.
2. Universal Milling Machine - 2 Nos.
3. Surface Grinding Machine - 1 No.
4. Cylindrical Grinding Machine - 1 No.
5. Tool and Cutter Grinder - 1 No.
6. Shaping Machine - 2 Nos.
7. Slotting Machine - 1 No.
8. Tools and Measuring instruments - Sufficient quantity.
9. Consumables - Sufficient quantity



DIRECTORATE OF TECHNICAL EDUCATION
DIPLOMA IN MECHANICAL ENGINEERING

M SCHEME

2015 -2016 onwards

www.binils.com
II YEAR
IV SEMESTER

**32047 – ELECTRICAL DRIVES AND CONTROL
PRACTICAL**

CURRICULUM DEVELOPMENT CENTRE

M-SCHEME

(Implements from the Academic year 2015-2016 onwards)

Course Name : DIPLOMA IN MECHANICAL ENGINEERING [MTMR]
Course Code : 2022
Subject Code : 32047
Semester : V
Subject Title : ELECTRICAL DRIVES AND CONTROL PRACTICAL

TEACHING AND SCHEME OF EXAMINATIONS:

No. of Weeks per Semester: 15 Weeks

Subject	Instructions		Examination			
	Hours/ Week	Hours/ Semester	Marks		Duration	
Electrical Drives and Control Practical	4	60	Internal Assessment	Board Examination	Total	3 Hrs
			25	75	100	

OBJECTIVES:

- Identify starters for different motors.
- Study and prepare earthing
- Test the characteristics of DC and AC machines.
- Identify and select controlling elements.
- Explore the performance of ELCB, MCB.
- Design regulated power supplies.
- Identify display devices - LED, 7 segment LED, LCD.
- Identify the drive circuit for special motors.
- Test the speed control circuit of the special motors

LIST OF EXPERIMENTS:

Part A:

1. Verification of Ohm's Law
2. Testing of DC starters – 3 point and 4 point starter
3. Load test on DC shunt motor
4. Testing of AC starters - DOL , star - Delta starter
5. Load test on single phase induction motor
6. Load test on three phase squirrel cage motor
7. Testing of relays, contactors, push buttons and limit switch
8. Connection and Testing of MCB, ELCB

Part B

9. Construction and testing of Half wave and Full wave rectifier.
10. Construction and testing of IC voltage regulator using IC 7805.
11. Verification of truth tables for logic gates.
12. Verification of universal gates.
13. Identification and testing of display devices- LED, 7 segment LED, Laser diode.
14. Testing of Stepper motor drive.
15. Testing of Servo motor drive.

BOARD EXAMINATION

Note: All the exercises are to be completed. One exercise from Part A and another one from Part B should be given for the Examination.

Part A:		35
	Circuit diagram	05
	Connections & Readings	15
	Calculations & Graph	15
Part B:		35
	Circuit diagram	05
	Connections & Readings	15
	Execution	15
	Viva Voce	5
Total		75

LIST OF EQUIPMENTS

Electrical Lab

1. DC ammeter 0-5A	-	1no
2. DC ammeter 0-25A	-	1no
3. DC voltmeter 0-30V	-	1no
4. DC voltmeter 0-300V	-	1no
5. Rheostat 10.8 ,8.5A	-	1no
6. AC ammeter 0-5A	-	1no
7. AC ammeter 0-10A	-	2nos.
8. AC voltmeter 0-50V	-	3nos
9. AC wattmeter 5A-10A (0-750W,0-600V)	-	3nos
10. Loading rheostat 5A,230V	-	1no
11. Tachometer 0-1000rpm (Analog type)	-	1no
12. Variac 20A,250V (Auto transformer)	-	2nos
13. 3 point starter 20A,220V	-	1no

14. DOL starter 16A,415V	-	1no
15. Star /Delta starter 20a,600V	-	1no
16. Over load relay 1 to 2.5A	-	1no
17. Air break contactors 20A,220V	-	4nos
18. Push button 2A ,220V	-	2nos
19. Limit switch 20A,220V	-	1no
20. MCB 20A single pole	-	1no
21. MCB 20A double pole	-	1no
22. ELCB 2pole 20A,100mA	-	1no
23. ELCB 4POLE 20A,100mA	-	1no

Electronics Lab

1. Transformer 230 / 9-0-9V, 1A	-	4 nos.
2. Resistor 1 K Ω / ½ W	-	3 nos.
3. Capacitor 1000 μ F/25V	-	4 nos.
4. IC 7805	-	1 no.
5. Logic Gates IC		
7400, 7408, 7432, 7404, 7402, 7486-		1 each
6. Stepper Motor Drive kit	-	1no.
7. Servo Motor Drive Kit	-	1no
8. Digital Multimeter	-	1no.
9. LED, 7Segment LED, Laser Diode -		1 each



DIRECTORATE OF TECHNICAL EDUCATION

**DIPLOMA IN MECHANICAL ENGINEERING (MACHINE TOOL MAINTENANCE
AND REPAIRS) (SANDWICH)**

III YEAR

M – SCHEME

V SEMESTER

2015 -2016 onwards

39258

THERMAL EQUIPMENTS PERFORMANCE PRACTICAL

CURRICULUM DEVELOPMENT CENTRE

M-SCHEME

(Implements from the Academic year 2015-2016 onwards)

Course Name : DIPLOMA IN MECHANICAL ENGINEERING (Machine Tool Maintenance and Repairs)

Course Code: 2022

Subject Code: 39258

Semester: V

Subject Title: THERMAL EQUIPMENTS PERFORMANCE PRACTICAL

Subject	Instructions		Examination			
	Hours / Week	Hours /Semester	Marks		Duration	
THERMAL EQUIPMENTS PERFORMANCE PRACTICAL	4	60	Internal Assessment	Board Examination	Total	3 Hrs
			25	75	100	

Rational :

The students studying maintenance should knowledge of lubricants, components of engines, tools which they suppose to handle and fundamentals wiring diagrams

Objectives :

- To know the properties lubricants
- To components of engines
- To know the tools
- To know the wiring diagram
- Flash and fire points oil
- Valve timing diagram and Port timing diagram of petrol engines
- Valve timing diagram and Port timing diagram of diesel engines
- Components like of automobile
- Wiring diagram

Exercises

1. Determining flash and fire points of the given oil using open cup apparatus
2. Determining flash and fire points of the given oil using close cup apparatus.
3. Valve timing diagram and Port timing diagram of petrol engines
4. Valve timing diagram and Port timing diagram of diesel engines
5. Removing, charging and replacing the BATTERY from a car.
6. Identification of various components of Ignition system.
7. Dismantling and Overhauling of a Distributor, Setting Contact Breaker Points
8. Servicing of Spark Plugs.
9. Measurement of voltage, current and resistance by using millimeter (both analog and digital) in all ranges.
10. Study of R&AC tools
11. Wiring diagram of Refrigerator
12. Performance test of evaporator
13. Performance test of condenser
14. Determination of COP of vapour compression system
15. Determination of various air conditioning processes by using air washer

BOARD EXAMINATION

Note: All the exercises in both sections have to be completed.

All the exercises should be given in the question paper and students are allowed to select by a lot.

Record note book should be submitted during examination.

Detailed allocation

Procedure	-	10 Marks
Drawing	-	20 Marks
Tabulation	-	10 Marks
Observation and Calculation	-	25 Marks
Viva-voce	-	05 marks
Result	-	05 Marks
Total	-	75 marks

List of Equipments

Batch Size :

30

S No	Name Of The Equipment / Tools	Quantity
1	Open Cup Apparatus	1
2	Close Cup Apparatus	1
3	Cut Section Petrol Engine	1
4	Cut Section Diesel Engine	1
5	Evaporator (Window Air Conditioner or Split Air Conditioner)	1
6	Condenser (Window Air Conditioner or Split Air Conditioner)	1
7	Air washer	1



DIRECTORATE OF TECHNICAL EDUCATION

**DIPLOMA IN MECHANICAL ENGINEERING (MACHINE TOOL MAINTENANCE
AND REPAIRS) (SANDWICH)**

III YEAR

M – SCHEME

VI SEMESTER

2015 -2016 onwards
www.binils.com

39261

INDUSTRIAL AUTOMATION

CURRICULUM DEVELOPMENT CENTRE

M-SCHEME

(Implements from the Academic year 2015-2016 onwards)

Course Name: DIPLOMA IN MECHANICAL ENGINEERING (Machine Tool

Maintenance and Repairs)

Course Code: 2022

Subject Code: 39261

Semester: VI

Subject Title: INDUSTRIAL AUTOMATION

Subject	Instructions		Examination			
	Hours / Week	Hours /Semester	Marks		Duration	
INDUSTRIAL AUTOMATION	5	75	Internal Assessment	Board Examination	Total	3 Hrs
			25	75	100	

Topics and Allocation of Hours:

S.No	Topic	Hours
1	Introduction To CNC And Types CNC Machines	14
2	Components Of CNC Machine	14
3	Part Programming	14
4	FMS, Integrated Material Handling And Robot	14
5	Maintenance Of CNC Machines	14
6	Test and Revision	5
	Total	75

RATIONALE:

As per the latest requirements in the Industries this enables to learn the assistance of computer in the field of design and manufacturing areas. It's able to learn the latest manufacturing concepts of in the shop floors and manufacturing methods like RPT. They are able to know about the working of principles of CNC machines and programming techniques are included. The application of material handling equipments and robots are learnt based on the automation in the industries.

Objectives:

- Introduction To CNC And Types CNC Machines
- Components Of CNC Machine

- Part Programming
- FMS, Integrated Material Handling And Robot
- Maintenance Of CNC Machines

INDUSTRIAL AUTOMATION
Detailed Syllabus

Unit	Name of the Topic	Hours
I	<p>INTRODUCTION TO CNC And TYPES CNC MACHINES</p> <p>INTRODUCTIN TO CNC : Numerical Control – definition – components of NC machines – development of NC – DNC – Working of CNC System – Features of CNC machines – advantages of CNC machines – Difference between NC and CNC</p> <p>TYPES OF CNC MACHINES: construction and Working Principle of turning centre – construction and working principle of machining centers- Machine axes conventions for turning centre and machining centers – design consideration of NC machine tools – CNC EDM machine – working principle of die sinking and wire EDM machines – Coordinate Measuring Machines – construction and working principles.</p>	14
II	<p>COMPONENTS OF CNC MACHINE</p> <p>Drives: Spindle Drive – DC Motor – Feed Drives – DC Servo Motor and Stepper Motor – hydraulic System – Slide ways requirement – types – friction slide ways and antifriction slide ways – linear motion bearings – recirculation ball screw – Automatic tool changing – Tool Magazines – feedback devices – linear and rotary transducers – encoders – in process probing</p>	14
III	<p>PART PROGRAMMING</p> <p>NC Part programming – methods – manual programming – conversational programming- APT Programming – format – sequential and word address formats – sequence number – coordinate system – types of motion control: point to point, paraxial and contouring – Datum points, machine zero, work zero, tool zero. NC dimensioning – preparatory functions and G Codes, M Codes – interpolation, linear program and circular interpolation – CNC program procedure: Part program – subprogram – macro program – canned cycles: sample</p>	14

	programs for lathe – linear and circular interpolation – stock removal turning – peck drilling thread cutting and sample programs for milling: Linear and circular interpolation.	
IV	<p>FMS, INTEGRATED MATERIAL HANDING AND ROBOT</p> <p>Types of Manufacturing: Introduction to FMS – FMS Components – FMS Layout – Types of FMS – flexible manufacturing cell – flexible turning cell – flexible transfer line – flexible manufacturing system – benefits of FMS – Computer Integrated Material Handling – AGV working principle – types – benefits – Automatic Storage and Retrieval System (ASRS)</p> <p>ROBOT: Definition – robot configurations – basic robot motion – robot programming method – robotic sensors – industrial applications: Characteristics, material transfer, machine loading, welding, spray painting, assembly and inspection.</p>	14
V	<p>VMaintenance of CNC Machines</p> <p>Introduction – objective – Documentation of maintenance program – spare parts – preventive maintenance – periodic inspection of parts – relays – servomotor bearing – servomotor oil rings – V rings – Replacing Drive units – Replacement procedure – Replacing battery – Replacing procedure – replacing the fuse – Servo system maintenance – Spindle system maintenance – Drive unit maintenance – Maintenance schedule – Daily – Monthly – Every three months – Every six months</p>	14

Text Books :

- 1) CAD/CAM/CIM , R.Radhakrishnan, S.Subramanian, New Age International Pvt. Ltd.
- 2) CAD/CAM , Mikell P.Groover, Emory Zimmers, Jr.Prentice Hall of India Pvt., Ltd.
- 3) NC Programming, S.K.Sinha, Galgotia Publications Pvt. Ltd.

Reference Books :

- 1) CAD/CAM Principles and Applications, Dr.P.N.Rao, Tata Mc Graw Hill Publishing Company Ltd.

2) CAD/CAM, Ibrahim Zeid, Mastering Tata McGraw-Hill Publishing Company Ltd., New Delhi.

3) Automation, Production Systems, and Computer-Integrated Manufacturing, Mikell P. Groover, Pearson Education Asia.

4) Computer control of manufacturing systems, Yoram Koren, McGraw Hill Book

www.binils.com



DIRECTORATE OF TECHNICAL EDUCATION

**DIPLOMA IN MECHANICAL ENGINEERING (MACHINE TOOL MAINTENANCE
AND REPAIRS) (SANDWICH)**

III YEAR

M – SCHEME

VI SEMESTER

2015 -2016 onwards

www.binits.com

39262

AUXILIARY EQUIPMENT MAINTENANCE

CURRICULUM DEVELOPMENT CENTRE

M-SCHEME

(Implements from the Academic year 2015-2016 onwards)

Course Name: DIPLOMA IN MECHANICAL ENGINEERING (Machine Tool

Maintenance and Repairs)

Course Code: 2022

Subject Code: 39262

Semester: VI

Subject Title: AUXILIARY EQUIPMENT MAINTENANCE

Subject	Instructions		Examination			
	Hours / Week	Hours /Semester	Marks		Duration	
Auxiliary Equipment Maintenance	5	75	Internal Assessment	Board Examination	Total	3 Hrs
			25	75	100	

Topics and Allocation of Hours:

Unit	Topic	Hours
1	Maintenance of portable tools, compressors	14
2	Maintenance of material handling equipments	14
3	Maintenance of I.C engines	14
4	Maintenance of hydraulic drive transmission elements	14
5	Maintenance of industrial housekeeping and safety equipments.	14
6	Test and Revision	5
	Total	75

RATIONALE:

The exponential growth of engineering industries has made a wide scope for maintenance engineering. The student studying maintenance should have a thorough knowledge in maintenance of portable tools, compressors, Transmission systems and maintenance of I.C engines and safety in industries

Objectives:

- To know the maintenance of portable tools, compressors
- To know the maintenance of material handling equipments

- To know the maintenance of I.C engines
- To know the maintenance of hydraulic drive transmission elements
- To know the maintenance of industrial housekeeping and safety equipments

Auxiliary Equipment Maintenance

Detailed Syllabus

Unit	Name of the Topic	Hours
I	<p>MAINTENANCE OF PORTABLE TOOLS, COMPRESSORS;</p> <p>a) Maintenance of portable electric tools: Bearing, gearing, electric cord, brushes, switches and motor – cordless electric tools – inspection and maintenance of portable drills, screw drivers impact wrenches, sanders, portable grinders, shear, nibblers, circular saws reciprocating saws – routers and hammers.</p> <p>b) Maintenance of Portable Pneumatic tools: Lubrication - maintenance procedure for precision tools, chipping hammer sealers, rotating tools and portable grinders.</p> <p>c) Servicing and operation of simple air compressor plant. Air compressor plant – servicing of air compressor plant – daily, weekly periodic maintenance</p>	14
II	<p>MAINTENANCE OF MATERIAL HANDLING EQUIPMENT:</p> <p>a) Maintenance of material handling equipment: Maintenance of rope – wire rope and fiber rope – chain hoist- types of chain hoists-maintenance of hoisting equipment – wrench</p> <p>b) E.O.T. crane – inspection of cranes with inspection report- crane maintenance-maintenance of belt and chain conveyors – maintenance of hydraulic and pneumatic conveyors</p>	14
III	<p>MAINTENANCE OF I.C ENGINES:</p> <p>I.C. Engines: 2 stroke – 4 stroke engines – valve timing diagram – port operation and working principle. Components of 2 stroke and 4 stroke engine – lubrication system – cylinder – cylinder head – crank case piston, rings – connecting rod –</p>	14

	<p>rocker arm – pull and push rod – valve spring – crank shaft – cam shaft timing gears – ignition system – coil ignition system – magneto ignition system – electronic ignition system – simple carburetor – working principle and fuel injection systems – maintenance of petrol and diesel engines.</p>	
IV	<p>MAINTENANCE OF HYDRAULIC DRIVE TRANSMISSION ELEMENTS:- Hydraulic drives a) Input elements- hydraulic power pack unit -filter, oil tank, pressure gauge, pump and motor unit, safety valve b) Control elements;- valves-repair of pressure control valves-repair of directional control valves -repair of flow control valves- c) Output elements ; -Repair of hydraulic cylinders and motors– replacement of seals and packing -troubles in the hydraulic drive and their causes – technical conditions for the assembly of hydraulic transmission – pumps and their repairs.</p>	14
V	<p>MAINTENANCE OF INDUSTRIAL HOUSE KEEPING AND SAFETY EQUIPMENTS: a) Housekeeping;- Requirement of good housekeeping-proper layout and equipment-correct material handling and storage-cleanliness and orderliness-maintenance of housekeeping-house keeping incentive plan-maintenance responsibility for improving housekeeping- b) Safety equipments: Personnel protective equipments – guarding metal working machines – lathe, milling, grinding, shaping, cold metal forming, punching and shearing machines – C) firefighting equipments CO₂-soda acid – carbon tetra chloride – dry powder – foam. fire protection from electrical hazard.</p>	14

TEXT BOOK

1. Maintenance Engineering Hand book by L.C. Morrow

Reference Book

1. Industrial Maintenance by H.P. Garg – chand& Co

www.binils.com



DIRECTORATE OF TECHNICAL EDUCATION

**DIPLOMA IN MECHANICAL ENGINEERING (MACHINE TOOL MAINTENANCE
AND REPAIRS) (SANDWICH)**

III YEAR

M – SCHEME

VI SEMESTER

2015 -2016 onwards

www.binils.com

**39263 TOTAL QUALITY MANAGEMENT AND TOTAL PRODUCTIVE
MAINTENANCE**

CURRICULUM DEVELOPMENT CENTRE

M-SCHEME

(Implements from the Academic year 2015-2016 onwards)

Course Name: DIPLOMA IN MECHANICAL ENGINEERING (Machine Tool

Maintenance and Repairs)

Course Code: 2022

Subject Code : 39263

Semester : VI

Subject Title : TOTAL QUALITY MANAGEMENT AND TOTAL PRODUCTIVE
MAINTENANCE

Subject	Instructions		Examination			Duration
	Hours / Week	Hours /Semester	Marks			
TOTAL QUALITY MANAGEMENT AND TOTAL PRODUCTIVE MAINTENANCE	4	60	Internal Assessment	Board Examination	Total	3 Hrs
			25	75	100	

Topics and Allocation of Hours:

S.No	Topic	Hours
1	Basic Concepts of Total Quality Management	11
2	Statistical Fundamentals	11
3	Overview of TPM	11
4	Aspects of TPM	11
5	Autonomous Maintenance	11

RATIONALE:

Total Productive Maintenance (TPM) is a very popular manufacturing philosophy and well accepted the world over. The TPM aims at creating a system for achieving and maintaining zero breakdown, zero defects, zero accident and zero pollution

Objectives:

- To know the Basic Concepts of Total Quality Management
- To know the Statistical Fundamentals

- To have Overview of TPM
- To know the Aspects of TPM
- To know the Autonomous Maintenance

**TOTAL QUALITY MANAGEMENT AND TOTAL PRODUCTIVE MAINTENANCE
Detailed Syllabus**

Unit	Name of the Topic	Hours
I	BASIC CONCEPTS OF TOTAL QUALITY MANAGEMENT Quality-Definitions- Dimensions of quality-Brainstorming and its objectives-Introduction to TQM – Characteristics – Basic concepts – Elements –Pillars – Principles - Obstacles to TQM implementation – Potential benefits of TQM – Quality council – Duties – Responsibilities – Quality statements – Vision – Mission – Quality policy statements – Strategic planning – Seven steps to strategic planning – Deming philosophy- Customer delight-ISO 9001:2008 Quality Management System requirements and implementation	11
II	STATISTICAL FUNDAMENTALS Types of Data – Collection of Data – Classification of Data – Tabular presentation of Data – Graphical representation of a frequency distribution– Comparison of Frequency distribution – Mean – Median – Mode – Comparison of measures of central tendency – Introduction to measures of dispersion – Sample – sampling - Normal curve – Sigma – Concept of six sigma – Principles – Process	11
III	Overview of TPM Introduction – Background of TPM- Japanese movement – terotechnology – logistics – comparative analysis of TPM, terotechnology and logistics - Definition of TPM – Features of TPM – Working of TPM – Benefits of TPM – stages and Steps of TPM –Stage A - Preparation stage – announcement by management - – initial Education and propaganda – Setting up of TPM and departmental Committee- Model TPM - – Establishing TPM working system – master plan for	11

	<p>institutionalizing – Stage B- initial implementation stage- starting TPM or- kick off -Stage C- full implementation or full development stage – establishing system for improving production efficiency - – Individual Improvement – Autonomous Maintenance – Planned Maintenance – operation and maintenance skill upgradation training - Establishing initial control system for new products and equipments- establishing quality maintenance – organization (HinshitsuHozen)- Establishing systems to improve efficiency of administration - Establishing system to control safety and working environment – Maturity stage – getting the PM award.</p>	
IV	<p>Aspects of TPM</p> <p>Equipment effectiveness and types of losses – suspension loss- plant maintenance loss – production adjustment loss - Downtime loss – equipment failure loss- process failure loss – Speed loss-regular production loss-irregular production loss- Defect Loss- Process defect loss – loss which caused by rework- Understanding the production system to reduce or eliminate losses- definition - process-operation- Calculating overall Equipment Effectiveness (OEE) – TPM Principles and Zero failures-Establishing basic condition-Keep operating records good – prevent equipment from deterioration-Improve weak points in design-Improve skills-set up and adjustment time loss reduction -Internal and external changes.</p>	11
V	<p>Autonomous Maintenance</p> <p>Concept of jishuhozen (autonomous maintenance) – steps- initial cleanup – preventive measures – preparation of maintenance standards – creating achievement motivation – general inspection– Preparing autonomous standards for TPM – autonomous inspection – standardization - autonomous management – check points for JishuHozen – institutionalize JishuHozen - why why analysis –Cause and effect diagram – ten kinds of human errors different kinds of defects</p>	11

Text Book:

1. Total Productive Maintenance by K. Ganapathy .V.Narayana, B.Subramaniam and D.K. Srivarsa published quality circle forum of India October 2004

Reference Book :

1. "Total Quality Management", Date H.Besterfiled, Pearson Education Asia. (Indian reprint 2002)

www.binils.com



DIRECTORATE OF TECHNICAL EDUCATION

**DIPLOMA IN MECHANICAL ENGINEERING (MACHINE TOOL MAINTENANCE
AND REPAIRS) (SANDWICH)**

III YEAR

M – SCHEME

VI SEMESTER

2015 -2016 onwards

39264

MACHINE TOOL RECONDITIONING & OVERHAULING

CURRICULUM DEVELOPMENT CENTRE

M-SCHEME

(Implements from the Academic year 2015-2016 onwards)

Course Name: DIPLOMA IN MECHANICAL ENGINEERING (Machine Tool

Maintenance and Repairs)

Course Code: 2022

Subject Code: 39264

Semester : VI

Subject Title : MACHINE TOOL RECONDITIONING & OVERHAULING

Subject	Instructions		Examination			
	Hours / Week	Hours /Semester	Marks		Duration	
Machine Tool Reconditioning & Overhauling	4	60	Internal Assessment	Board Examination	Total	3 Hrs
			25	75	100	

Topics and Allocation of Hours:

Unit	Topic	Hours
1	Reconditioning Of Machine Tools	11
2	Maintenance Activity And Major Overhaul Machine Tools	11
3	Principles of Acceptance Test	11
4	Details of Testing of Various Machine Tools	11
5	Condition Based Maintenance	11
6	Test and Revision	5
	Total	60

RATIONALE:

The exponential growth of engineering industries has made a wide scope for maintenance engineering. The student studying maintenance should have a thorough knowledge in various aspects of maintenance engineering

Objectives :

- To know about Reconditioning Of Machine Tools
- To know about Maintenance Activity And Major Overhaul Machine Tools

- To know about Principles of Acceptance Test
- To know about Details of Testing of Various Machine Tools
- To know about Condition Based Maintenance

Machine Tool Reconditioning & Overhauling

Detailed Syllabus

Unit	Name of the Topic	Hours
I	<p>Reconditioning Of Machine Tools</p> <p>1.1 Sequence of maintenance operation: Procedure disassembly of machine tools, preparation of disassembly sequence and rules- examples of disassembly- washing of parts faultfinding- preparation for assembly- fitting in- balance of parts assembly of mechanisms and machines.</p> <p>1.2 Scraping: Importance of scraping- techniques of scraping tools used for scraping- accuracy, tolerances and finish.</p> <p>1.3 Reconditioning of machining parts: Methods of determining wear of guides, Selection of repair method and sequence –Method of checking – Non –linear – twist – parallelism of bed way– universal bridge – use and importance. Repairing parts with flat conjugate- surfaces- general- restoring parts like: bed ways of lathe- column way of a plain milling machine- saddle ways of lathe table saddle ways of a milling machine- knee ways of a milling machine- table ways of a milling machine- ways of press slides anvil blocks of hammers- clamping blocks and wedges</p>	11
II	<p>Maintenance Activity And Major Overhaul Machine Tools</p> <p>Maintenance – Definition – types – Preventive maintenance – advantages – procedure – break down maintenance. Example of an engine lathe overhaul. Inspecting and checking before repair Disassembly- mounting and aligning the feed gear box- apron, lead screw and feed rod bracket- repairing the tailstock – headstock spindle – three jaw chuck – lead screw and nut –</p>	11

	cracks in a cast iron body – technical requirements for the repaired lathe –standard chart for major overhaul of an engine lathe.	
III	<p>Principles of Acceptance Test</p> <p>3.1 Acceptance Test: Acceptance test- reason for test-principles of acceptance test- machine tool under load – test charts execution of acceptance test – measuring equipments and methods.</p> <p>3.2 Dial Gauges: Dial gauges – test mandrels – straight edges -squares- spirit levels- level measurement by water level-alignment by wire and measuring microscope.</p> <p>3.3 Alignment by Telescope: Alignment by telescope and target magnitudes and direction of tolerances- straightness of slide ways and flatness of tables- alignment and true running of shafts- lead or pitch error of lead screws- pitch errors of gears and dividing errors of dividing heads</p>	11
IV	<p>Details of Testing of Various Machine Tools</p> <p>4.1 Milling and Gear cutting machines: Milling and gear cutting machines – lathes - capstan and turret lathes, automatic lathes and vertical boring machines.</p> <p>4.2 Grinding Machines: Grinding machines - drilling and boring machines - Acceptance tests and maintenance of machine tools. Test specification - the accuracy with which the machine has been manufactured - installation and leveling of the machines – testing the quality of slide ways and locating surfaces - testing the accuracy of the main spindle and of its alignment relative to other important parts of the machine</p> <p>4.3 Accuracy of the work Produced: Accuracy of the work piece produced on the machine – power requirements - ISI test charts and detailed procedure – lathe, milling machine, grinding machine- drilling machines.</p>	11
V	Condition Based Maintenance	11

	<p>5.1 Condition monitoring: Categories of condition monitoring methods-on load monitoring techniques- temperature monitoring –lubricating monitoring – leak detection – vibrating monitoring –noise monitoring – corrosion monitoring.</p> <p>5.2 Off- load monitoring: Crack detection – leak detection - vibration testing - corrosion monitoring - general purpose monitoring techniques - the systematic application of C.M.</p> <p>5.3 Lubricating monitoring: Debris deposited- debris in suspension- condition of used oil- ferrography.</p> <p>Thermal monitoring: Location of temperature measurement – temperature monitoring devices- contact sensors, liquid expansion sensors, bimetallic expansion sensors, thermocouple sensors, resistance sensors – temperature paints, Crayons and pellets- noncontact sensors- optical pyrometer, radiation pyrometer. Scanning DR camera. Malfunction that can be monitored thermally.</p> <p>5.4 Vibration and noise monitoring: The cause of vibration and noise – measurement – equipment. The vibration or noise signals -vibration monitoring techniques- total signal monitoring – peak signal monitoring figure of merit shock pulse monitoring.</p>	
--	---	--

Text Book:

1. Industrial maintenance by HP Garg - S. Chand&Co, 1987
2. Management of industrial maintenance by A. Kelley &M.J.Harris- Morgan-Grampian (Publishers), 1978

Reference book:

1. Testing of machines Tools by DR.Georg Schlesinger - Machinery Publishing Company Limited. -1949



DIRECTORATE OF TECHNICAL EDUCATION

**DIPLOMA IN MECHANICAL ENGINEERING (MACHINE TOOL MAINTENANCE
AND REPAIRS) (SANDWICH)**

III YEAR

M – SCHEME

VI SEMESTER

2015 -2016 onwards

www.binils.com

39265

ENGINEERING MANAGEMENT

CURRICULUM DEVELOPMENT CENTRE

M-SCHEME

(Implements from the Academic year 2015-2016 onwards)

Course Name : DIPLOMA IN MECHANICAL ENGINEERING (Machine Tool

Maintenance and Repairs)

Course Code : 2022

Subject Code : 39265

Semester : VI

Subject Title : **ENGINEERING MANAGEMENT**

Subject	Instructions		Examination			
	Hours / Week	Hours /Semester	Marks		Duration	
Engineering Management	4	60	Internal Assessment	Board Examination	Total	3 Hrs
			25	75	100	

Topics and Allocation of Hours:

S.No	Topic	Hours
1	Plant Engineering And Plant Safety	11
2	Work Study, Method Study And Work Measurement	11
3	Production Planning And Quality Control	11
4	Principles Of Management And Personnel Management	11
5	Maintenance Management And Material Management	11
6	Test and Revision	5
	Total	60

RATIONALE:

In the Indian Economy, Industries and enterprises always find prominent place. After globalization, the government of India has announced liberalization policy of starting an enterprise which resulted in the mushroom growth of industries. The present day students should be trained not only in manufacturing processes but also in managing activities of industries. Training must be imparted to students not only to shape them as technicians but also as good managers. The knowledge about plant, safety, work study techniques,

personnel management will definitely mould the students as managers to suit the industries. Due to the presence of such personalities the industries will leap for better prosperity and development

Objectives :

- To know about Plant Engineering And Plant Safety
- To know about Work Study, Method Study And Work Measurement
- To know about Production Planning And Quality Control
- To know about Principles Of Management And Personnel Management
- To know about Maintenance Management And Material Management

www.binils.com

**ENGINEERING MANAGEMENT
Detailed Syllabus**

Unit	Name of the Topic	Hours
I	<p>PLANT ENGINEERING AND PLANT SAFETY</p> <p>Plant Engineering :Plant – Selection of site of industry – Plant layout –Principles of a good layout – types – process, product and fixed position –techniques to improve layout – Principles of material handling equipment</p> <p>Plant Safety: Importance –accident-causes and cost of an accident-accident proneness-prevention of accidents-Industrial disputes-settlement of Industrial disputes-Collective bargaining, conciliation, Mediation, arbitration-Indian Factories Act 1948 and its provisions related to health, welfare and safety</p>	11
II	<p>WORK STUDY, METHOD STUDY AND WORK MEASUREMENT</p> <p>Work Study: Productivity – Standard of living – method of improving productivity– Objectives – Importance of good working conditions.</p> <p>Method Study: Definition – Objectives – Selection of a job for method study –Basic procedure for conduct of method study – Tools used – Operation process chart, Flow process chart.</p> <p>.Work Measurement: Definition – Basic procedure in making a time study –Employees rating factor – Application of time allowances – Rest, Personal, Process, Special and Policy allowances – Calculation of standard time –Problems – Basic concept of production study – Techniques of work measurement-Ratio delay study.</p>	11
III	<p>PRODUCTION PLANNING AND QUALITY CONTROL</p> <p>Production Planning and Control: Introduction – Major functions of production planning and control – Pre planning – Methods of forecasting – Routing and scheduling – Dispatching and controlling – Concept of Critical Path Method(CPM)-</p>	11

	<p>Description only. Production – types-Mass production, batch production and job order production- Characteristics – Economic Batch Quantity (EBQ) –Principles of product and process planning – make or buy decision.</p> <p>Quality Control: Definition – Objectives – Types of inspection – First piece, Floor and centralized inspection – Advantages and disadvantages. Quality control – Statistical quality control – Types of measurements – Method of variables – Method of attributes – Uses of X, R, p and c charts– Concept of ISO 9001:2008 Quality Management System Registration / Certification procedure – Benefits of ISO to the organization.</p>	
IV	<p>PRINCIPLES OF MANAGEMENT AND PERSONNEL MANAGEMENT</p> <p>Principles of Management: Definition of management – Administration -Organization – F.W. Taylor’s and Henry Fayal’s Principles of Management –Functions of Manager – Types of Organization – Line, Staff, Taylor’s Pure functional types – Line and staff and committee type – Directing – Leadership - Styles of Leadership – Qualities of a good leader – Motivation – Positive and negative motivation</p> <p>Personnel Management: Responsibility of human resource management –Selection procedure – Training of workers – Apprentice training – On the job training and vestibule school training – Job evaluation and merit rating –objectives and importance – wages and salary administration – Components of wages – Wage fixation – Type of wage payment</p>	11
V	<p>V MAINTENANCE MANAGEMENT AND MATERIAL MANAGEMENT</p> <p>Maintenance Management - types of maintenance strategies, Planned and unplanned maintenance, breakdown, preventive & predictive maintenance. Their comparison, advantages</p>	11

	<p>disadvantages. Limitations , computer aided maintenance, maintenance scheduling, spare part Management, inventory control, organization of maintenance department.</p> <p>Material management: Objectives of good stock control system – ABC analysis of inventory – Procurement and consumption cycle – Minimum Stock, Lead Time, Reorder Level-Economic order quantity problems – supply chain management –Introduction – Purchasing procedure – Store keeping – Bin card.</p>	
--	--	--

Text Books :

- 1) Industrial Engineering and Management, O.P. Khanna, Revised Edition Publications (P) Ltd – 2004, 67/4 Madras House, Daryaganj, New Delhi – 110002.
- 2) Engineering Economics and Management, T.R. Banga& S.C. Sharma, McGraw Hill Edition. – 2001, New Delhi.
- 3)Maintenance& Spare parts Management Gopal Krishnan
- 4) Industrial Maintenance Management S.K. Shrivastava

Reference Books :

- 1) Management, A global perspective, Heinz Wehrich, Harold Koontz, 10th Edition, McGraw Hill International Edition 1994.
- 2) Essentials of Management, 4th Edition, Joseph L.Massie, Prentice-Hall of India, New Delhi 2004.



DIRECTORATE OF TECHNICAL EDUCATION

**DIPLOMA IN MECHANICAL ENGINEERING (MACHINE TOOL MAINTENANCE
AND REPAIRS) (SANDWICH)**

III YEAR

M – SCHEME

VI SEMESTER

2015 -2016 onwards

www.binils.com

39266

CNC PROGRAMMING AND SIMULATION LAB

CURRICULUM DEVELOPMENT CENTRE

M-SCHEME

(Implements from the Academic year 2015-2016 onwards)

Course Name: DIPLOMA IN MECHANICAL ENGINEERING (Machine Tool

Maintenance and Repairs)

Course Code: 2022

Subject Code: 39266

Semester : VI

Subject Title: CNC Programming and Simulation Lab

Subject	Instructions		Examination			
	Hours / Week	Hours /Semester	Marks			Duration
CNC Programming and Simulation Lab	4	60	Internal Assessment	Board Examination	Total	3 Hrs
			25	75	100	

Rational:

The CNC Programming and Simulation Lab will give the students studying maintenance

Course a overview of CNC lathe, milling machine, international standard G Codes and M codes and incremental system and absolute systems

Objectives:

1. Study of CNC lathe, milling machine
2. Study of international standard G Codes and M codes
3. Study of incremental system and absolute system
4. Study of part program format
5. Study of canned cycles for lathe and milling
6. Program writing – turning simulator – milling simulator, IS practice – commands – menus

Exercise

CNC TURNING

Writing program using g01, g02 & g03

1. Step turning
2. Taper turning
3. Circular interpolation

writing program using canned cycle

4. Step turning
5. Taper turning
6. Circular interpolation
7. Multiple turning
8. Thread cutting and grooving
9. Internal drilling and boring

CNC milling

10. Linear interpolation
11. Circular interpolation
12. Linear and circular interpolation
13. Drilling and counter sinking
14. Mirroring
15. Pocketing

BOARD EXAMINATION

Note: All the exercises in both sections have to be completed.

All the exercises should be given in the question paper and students are allowed to select by a lot.

Record note book should be submitted during examination.

Detailed allocation

Program writing	-	40 Marks
Simulation	-	30 Marks
Viva-voce	-	05 marks

Total - 75 marks

www.binils.com

Equipment requirement:

Minimum Facilities required for 60 intakes.

1. Personal computer (Pentium processor) – 15 Nos.
2. Off line CNC Lathe and Milling simulation software – 15 users.
3. Laser Printer – 1 No.



DIRECTORATE OF TECHNICAL EDUCATION

**DIPLOMA IN MECHANICAL ENGINEERING (MACHINE TOOL MAINTENANCE
AND REPAIRS) (SANDWICH)**

III YEAR

M – SCHEME

VI SEMESTER

2015 -2016 onwards

39267

MAINTENANCE LAB I

CURRICULUM DEVELOPMENT CENTRE

M-SCHEME

(Implements from the Academic year 2015-2016 onwards)

Course Name: DIPLOMA IN MECHANICAL ENGINEERING (Machine Tool

Maintenance and Repairs)

Course Code: 2022

Subject Code: 39267

Semester: VI

Subject Title: Maintenance Lab I

Subject	Instructions		Examination			
	Hours / Week	Hours /Semester	Marks		Duration	
Maintenance Lab I	4	60	Internal Assessment	Board Examination	Total	3 Hrs
			25	75	100	

RATIONALE:

In Diploma level Engineering education skill development plays a vital role. The skill development can be achieved by on hand experience in handling various instruments, apparatus and equipment. This is accomplished by doing engineering related experiments in conducting alignment test for various machineries.

Objectives:

- To dismantle and assemble the components of lathe
- To dismantle and assemble motors
- Alignment Test for lathe
- Alignment Test for milling machine
- Alignment Test for Shaping machine
- Alignment Test for Testing of Tool and Cutter grinder
- Alignment Test for Testing of Pillar type drilling machine
- Alignment Test for Testing of Radial Drilling machine
- Alignment Test for Testing of Planning machine

Exercises:

1. Dismantling and assembly of tailstock of lathe
2. Dismantling and assembly of three jaw chuck
3. Dismantling and assembly of four jaw chuck
4. Dismantling and assembly of Bench vice
5. Dismantling and assembly of D C Motor
6. Dismantling and assembly of A.C. Induction Motor
7. Dismantling and assembly of Hydraulic cylinders
8. Dismantling and assembly of Directional control valve
9. Testing of lathe
10. Testing of Horizontal milling machine
11. Testing of Shaping machine
12. Testing of Tool and Cutter grinder
13. Testing of Pillar type drilling machine
14. Testing of Radial Drilling machine
15. Testing of Planning machine

BOARD EXAMINATION

Note: All the exercises in both sections have to be completed.

All the exercises should be given in the question paper and students are allowed to select by a lot.

Record note book should be submitted during examination.

Detailed allocation

Procedure	-	10 Marks
Alignment / Dismantling and Assembling	-	35 Marks
Drawing	-	20 Marks
Result	-	05 Marks
Viva-voce	-	05 marks
Total	-	75 marks

Equipment required

1. Tailstock of lathe - 1No
2. Three jaw chuck - 1No
3. Four jaw chuck - 1No
4. Bench vice - 1No
5. D C motor - 1No
6. A.C. induction motor - 1No
7. Hydraulic cylinders - 1No
8. Directional control valve - 1No
9. Lathe - 1No
10. Horizontal milling machine - 1No
11. Shaping machine - 1No
12. Tool and cutter grinder - 1No
13. Pillar type drilling machine - 1No
14. Radial drilling machine - 1No
15. Testing of planning machine - 1No



**DIRECTORATE OF TECHNICAL EDUCATION
DIPLOMA IN MECHANICAL ENGINEERING**

M SCHEME

2015 -2016 onwards

www.binils.com
**III YEAR
VI SEMESTER**

30002 – LIFE AND EMPLOYABILITY SKILLS PRACTICAL

CURRICULUM DEVELOPMENT CENTRE

STATE BOARD OF TECHNICAL EDUCATION & TRAINING, TAMILNADU

DIPLOMA IN ENGINEERING – SYLLABUS – M Scheme

(Being implemented from the Academic Year 2016-2017 onwards)

Course Name : **All Branches of Diploma in Engineering and Technology and Special Programmes**

Subject Code : **30002**

Semester : **VI**

Subject Title : **LIFE AND EMPLOYABILITY SKILLS PRACTICAL**

Teaching and Scheme of Examination: No. of Weeks per Semester: 15 Weeks

Subject	Instruction		Examination			
	Hours/Week	Hours/Semester	Marks			Duration
			Internal assessment	Board Examination	Total	
Life and Employability Skills	4 Hours	60 Hours	25	75	100	3 Hours

Topics and Allocation of Hours:

Sl. No.	Section	No. of Hours
1	Part – A Communication	30
2	Part – B Entrepreneurship, Project Preparation, Productivity,	20

	Occupational Safety, Health, Hazard, Quality Tools & Labour Welfare	
3	Part – C Environment, Global Warming, Pollution	10
TOTAL		60

RATIONALE

Against the backdrop of the needs of the Industries, as well as based on fulfilling the expectations of the Industries, the Diploma Level students have to be trained directly and indirectly in toning up their competency levels. Proficiency in Communication only, equips them with confidence and capacity to cope with the employment. Hence, there is a necessity to focus on these in the curriculum. At the end of the Course, the student is better equipped to express himself in oral and written communication effectively.

SPECIFIC INSTRUCTIONAL OBJECTIVES

1. Emphasize and Enhance Speaking Skills

2. Increase Ability to Express Views & Opinions

3. Develop and Enhance Employability Skills

4. Induce Entrepreneurship and Plan for the Future

5. Expose & Induce Life Skills for Effective Managerial Ability

LIFE AND EMPLOYABILITY SKILLS PRACTICAL

SYLLABUS

Unit	Topics	Activity	Hours
I	Communication, Listening, Training, Facing Interviews, Behavioural Skills	<ul style="list-style-type: none"> -- instant sentence making – say expressions/phrases-- self- introduction/another higher official in company – describe/explain product – frame questions based on patterns – make sentences based on patterns 	30
II	Entrepreneurship, Project Preparation, Marketing Analysis, Support & Procurement	<ul style="list-style-type: none"> -- prepare an outline of a project to obtain loan from bank in becoming an entrepreneur – prepare a resume 	10
III	Productivity – comparison with developed countries, Quality Tools, Circles, Consciousness, Management, House Keeping	<ul style="list-style-type: none"> -- search in the website -- prepare a presentation – discuss & interact 	05
IV	Occupational Safety, Health Hazard, Accident & Safety, First-Aid, Labour Welfare Legislation, Welfare Acts	<ul style="list-style-type: none"> -- search in the website -- prepare a presentation – discuss & interact 	05

V	Environment, Global Warming, Pollution	-- taking down notes / hints – answering questions -- fill in blanks the exact words heard	10
----------	---	---	-----------

www.binils.com

LEARNING STRUCTURE

100 Marks

- Focus more on Speaking & Listening Skills
- Attention less on Reading & Writing Skills
- Apply the skills in fulfilling the Objectives on Focused Topics

a) Listening	25 Marks
1. Deductive Reasoning Skills (taking down notes/hints)	10
2. Cognitive Skills (answering questions)	10
3. Retention Skills (filling in blanks with exact words heard)	05
b) Speaking Extempore/ Prepared	30 Marks
1. Personality/Psychological Skills (instant sentence making)	05
2. Pleasing & Amiable Skills (say in phrases/expressions)	05
3. Assertive Skills (introducing oneself/others)	05
4. Expressive Skills (describe/explain things)	05
5. Fluency/Compatibility Skills (dialogue)	05
6. Leadership/Team Spirit Skills (group discussion)	05
c) Writing & Reading	20 Marks
1. Creative & Reasoning Skills (frame questions on patterns)	05
2. Creative & Composing Skills (make sentences on patterns)	05
3. Attitude & Aim Skills (prepare resume)	05
4. Entrepreneurship Skills (prepare outline of a project)	05
d) Continuous Assessment (Internal Marks)	25 Marks
(search,read, write down, speak, listen, interact & discuss)	
1. Cognitive Skills (Google search on focused topics)	
2. Presentation Skills& Interactive Skills (after listening, discuss)	
Note down and present in the Record Note on any 5 topics	10 Marks
Other activities recorded in the Record note	10 Marks
Attendance	05 Marks
INTERNAL MARKS	25 MARKS
EXTERNAL MARKS AT END EXAMINATION	75 MARKS

MODEL QUESTION

Time: 3 Hours

Maximum Marks: 75

A. LISTENING

25 Marks

1. Listen to the content and take down notes/hints 10
2. Listen to the content and answer the following questions. 10
3. Listen to the content and fill in the blanks the exact words heard. 05

B. SPEAKING

30 Marks

1. Say in a sentence instantly on hearing the word(5 words, one after another). 05
2. Say any five expressions commonly used in communication. 05
3. Imagine, a consultant has come to your department.
Introduce him to your subordinates. 05
4. Explain/describe the product you are about to launch in the market. 05
5. Speak with your immediate boss about the progress you have made. 05
6. Discuss within the group on the topic of focus in the syllabus. 05

C. WRITING & READING

20 Marks

1. Frame new questions from the pattern given by changing sets of words with your own. 05

a.	When	do	you	return?
b.	How	is	his performance?	
c.	Where	has	the manager	gone?
d.	What	is	the progress	today?
e.	Why	are	the machines	not functioning?

2. Make sentences from the pattern given by changing sets of words with your own. 05

a.	The workers	are	on strike		
b.	The labourers	are paid	well	in this factory	
c.	There	is	a rest room	for the workers	

d.	These	are	the new products	launched	by our company
e.	Almost everyone	come	to the company	on motorbikes	

3. Prepare a resume for the post of Department Manager. 05
4. Prepare an outline of a project to obtain a loan. (Provide headings and subheadings) 05

I. Guidelines for setting the question paper:

A. LISTENING :

ONLY TOPICS related to
 POLLUTION /
 ENVIRONMENT /
 GLOBAL WARMING are to be taken.
 These topics are common for all the three types of evaluation.

B. SPEAKING :

1. WORDS of common usage
2. Fragments – expression of politeness, courtesy, cordiality
3. Introduce yourself as an engineer with designation or
 Introduce the official visiting your company/department
4. Describe/Explain the product/machine/department
5. Dialogue must be with someone in the place of work.
6. Group of six/eight
 Discuss the focused topic prescribed in syllabus

C. WRITING & READING:

1. Provide five different structures.
 Students are to substitute at least one with some other word/words
2. Provide five different structures.
 Students are to substitute at least one with some other word/words
3. Provide some post related to industries.
4. Outline of the project (skeleton/structure)
 Only the various headings and subheadings
 Content is not needed

II. Guidelines for recording the material on the Focused Topics in the Record note.

Write in the record note, **on any five topics**, from the list of topics given below. **10 Marks**
(5 topics x 10 marks = 50 marks. Thus, the **Average of 5 topics is 10 Marks**)

1. Productivity in Industries – Comparison with developed countries
2. Quality Tools, Quality Circles and Quality Consciousness
3. Effective Management
4. House Keeping in Industries
5. Occupational Safety and Hazard
6. Occupational Accident and First Aid
7. Labour Welfare Legislations
8. Labour Welfare Acts and Rights
9. Entrepreneurship
10. Marketing Analysis, Support and Procurement

LABORATORY REQUIREMENT:

1. An echo-free room
2. Necessary furniture and comfortable chairs
3. A minimum of two Computers with internet access
4. A minimum of two different English dailies
5. A minimum of Three Mikes with and without cords
6. Colour Television (minimum size – 29”)
7. DVD/VCD Player with Home Theatre speakers
8. Smart board
9. Projector

Suggested Reading:

1. Production and Operations Management by S.N. Chary, TMH
2. Essentials of Management by Koontz & Wehrich, TMH
3. Modern Production / Operations Management by E.S. Buffa and R.K. Sarin, John Wiley & Sons
4. Production Systems: Planning, Analysis and Control by J.L. Riggs, 3rd ed., Wiley.
5. Production and Operations Management by A. Muhlemann, J. Oakland and K. Lockyer, Macmillan
6. Operations Research - An Introduction by H.A. Taha, Prentice Hall of India
7. Operations Research by J.K. Sharma, Macmillan
8. Business Correspondence & Report Writing by R.C. Sharma and K. Mohan, TMH
9. How to prepare for Group Discussion & Interview (With Audio Cassette) by Prasad, TMH
10. Spoken English – A self-learning guide to conversation practice (with Cassette)
11. Introduction to Environmental Engineering by Mackenzie, L. Davis and A. David, Cornwell, McGrawHill, 3rd Ed.
12. Environmental Engineering by Peary, Rowe and Tchobanoglous, McGrawHill
13. Total Quality Management – An Introductory Text by Paul James, Prentice Hall
14. Quality Control and Applications by Housen & Ghose
15. Industrial Engineering Management by O.P. Khanna



DIRECTORATE OF TECHNICAL EDUCATION

**DIPLOMA IN MECHANICAL ENGINEERING (MACHINE TOOL MAINTENANCE
AND REPAIRS) (SANDWICH)**

M – SCHEME
www.binils.com

VII SEMESTER

2015 -2016 onwards

39271

MAINTENANCE LAB II

CURRICULUM DEVELOPMENT CENTRE

M-SCHEME

(Implements from the Academic year 2015-2016 onwards)

Course Name: DIPLOMA IN MECHANICAL ENGINEERING (Machine Tool

Maintenance and Repairs)

Course Code: 2022

Subject Code: 39271

Semester: VII

Subject Title: Maintenance Lab II

Subject	Instructions		Examination			
	Hours / Week	Hours /Semester	Marks		Duration	
Maintenance Lab II	4	60	Internal Assessment	Board Examination	Total	3 Hrs
			25	75	100	

RATIONALE:

The maintenance technicians should have a complete knowledge in determining the errors arising in machines. Further they should have knowledge handling portable tools.

Objectives:

- To determine errors in machine tools
- To determine wear of machine tools
- To know about portable tools

1. Conducting Non linearity test in bed ways of lathe using spirit level and feeler gauge method.
2. Conducting Non linearity test in bed ways of lathe using dial indicator with magnetic base method.
3. Conducting Straightness error test in the bed ways of lathe using dial indicator method.
4. Determining the amount of wear in the bedways of machine tool using straightedge and feeler gauge method
5. Determining the amount of wear in the bedways of machine tool using dial indicator method.
6. Determining the amount of wear in the bedways of machine tool using spirit level and feeler gauge method.
7. Conduct the flatness test in the centre lathe using spirit level and feeler gauge.
8. Conduct the spiral/twist error test using spirit level and feeler gauge.
9. Determine error in the lead or pitch error of lead screw of lathe by comparison with an end gauge method.
10. Determine error in the lead or pitch error of lead screw of lathe by Cazeneuve test.
11. Dismantle and assemble the given portable pneumatic drill.
12. Dismantle and assemble the given portable Electric drill.
13. Dismantle and assemble the speed reduction gearbox unit used in hoisting mechanism.
14. Dismantle and assemble the bearing assembly in a motor using bearing puller.
15. Conduct the alignment test in the pulley and belt drive mechanism using straight edge and slip gauge method.

BOARD EXAMINATION

Note: All the exercises in both sections have to be completed.

All the exercises should be given in the question paper and students are allowed to select by a lot.

Record note book should be submitted during examination.

Procedure	-	10 Marks
Alignment / Dismantling and Assembling	-	35 Marks
Drawing	-	20 Marks
Result	-	05 Marks
Viva-voce	-	05 marks
Total	-	75 marks

Equipment Requirement:

1. Spirit level
2. Feeler gauge
3. Dial indicator with magnetic base method.
4. Portable pneumatic drill.
5. Electric drill.
6. Speed reduction gearbox unit.



DIRECTORATE OF TECHNICAL EDUCATION
DIPLOMA IN MECHANICAL ENGINEERING
[MTMR]

www.binitis.com
M SCHEME
2015 -2016 onwards

VII SEMESTER

32055 – PROCESS AUTOMATION PRACTICAL

CURRICULUM DEVELOPMENT CENTRE

M-SCHEME

(Implements from the Academic year 2015-2016 onwards)

Course Name : DIPLOMA IN MECHANICAL ENGINEERING [MTMR]
Course Code : 2022
Subject Code : 32055
Semester : VII
Subject Title : PROCESS AUTOMATION PRACTICAL

TEACHING AND SCHEME OF EXAMINATIONS:

No. of Weeks per Semester: 15 Weeks

Subject	Instructions		Examination			
	Hours/ Week	Hours/ Semester	Marks			Duration
Process Automation Practical	4	60	Internal Assessment	Board Examination	Total	3 Hrs
			25	75	100	

OBJECTIVES:

- Design and operate pneumatic circuits.
- Design and operate fluid power circuits
- Use PLC system and its elements for process control
- Familiarize the working of function blocks in PLC
- Use ON-Delay timer to control a motor
- Use OFF-Delay timer to control a motor
- Use counter function block (Up counter and Down counter)
- Control the automatic operation of pneumatic cylinder using PLC
- Record of work to be prepared.

Exercises

Pneumatics Lab.

1. Direct operation of single and double acting cylinder.
2. Operation of double acting cylinder with quick exhaust valve.
3. Speed control of double acting cylinder using metering-in and metering-out circuits.
4. Automatic operation of double acting cylinder in single cycle - using limit switch.
5. Automatic operation of double acting cylinder in multi cycle - using limit switch.

Hydraulics Lab.

1. Direct operation of double acting cylinder.
2. Direct operation of hydraulic motor.
3. Speed control of double acting cylinder metering-in and metering-out control.

PLC Lab.

1. Direct operation of a motor using latching circuit.
2. Operation of a motor using 'AND' logic control.
3. Operation of a motor using 'OR' control.
4. On-Delay control of a motor and Off –Delay control of a motor.
5. Automatic operation of a Double acting cylinder-single cycle.
6. Automatic operation of a Double acting cylinder-single cycle - forward, time delay, return.
7. Automatic operation of Double acting cylinder-Multi cycle.
8. Sequential operation of double acting cylinder and a motor.

Board of Examination

Note: All the exercises have to be completed. Two exercises will be given for examination by selecting one exercise from Pneumatics Lab. or Hydraulics lab. and one from PLC lab.

All the exercises should be given in the question paper and students are allowed to select by a lot.

Record note book should be submitted during examination.

Allocation of Marks

Part A: Pneumatics/Hydraulics lab by lot	- 35 marks
Part B: One question from PLC lab.	- 35 marks
Viva-voce	- 05 marks
Total	- 75 marks

LIST OF EQUIPMENTS

1. Pneumatic Trainer Kit – 2Nos
(All Cylinders, Control Valves, Limit switches and other accessories)
2. Hydraulics Trainer Kit – 1No.
(All Cylinders, Control Valves, Limit switches and other accessories)
3. PLC kit. – 2 Nos.
4. Computer with software – 5 Nos.



DIRECTORATE OF TECHNICAL EDUCATION
DIPLOMA IN MECHANICAL ENGINEERING

M SCHEME

2015 -2016 onwards

www.binils.com
III YEAR
VI SEMESTER

39273 – PROJECT WORK

CURRICULUM DEVELOPMENT CENTRE

M-SCHEME

(Implements from the Academic year 2015-2016 onwards)

Course Name : **DIPLOMA IN MECHANICAL ENGINEERING [MTMR]**
Course Code : **2022**
Subject Code : **39273**
Semester : **VII**
Subject Title : **Project Work**

.TEACHING AND SCHEME OF EXAMINATIONS:

No. of Weeks per Semester: 15 Weeks

Subject	Instruction		Examination		
	Hours/ Week	Hours/ Semester	Assessment Marks		
			Internal	Board Exam	Total
PROJECT WORK	4	60	25	75	100

Minimum Marks for Pass is 50 out of which minimum 35 marks should be obtained out of 75 marks in the board Examination alone.

OBJECTIVES:

- Implement the theoretical and practical knowledge gained through the curriculum into an application suitable for a real practical working environment preferably in an industrial environment
- Get exposure on industrial environment and its work ethics.
- Understand what entrepreneurship is and how to become an entrepreneur.
- Learn and understand the gap between the technological knowledge acquired through curriculum and the actual industrial need and to compensate it by acquiring additional knowledge as required.
- Carry out cooperative learning through synchronous guided discussions within the class in key dates, asynchronous document sharing and discussions, as well as to prepare collaborative edition of the final project report.
- Understand the facts and importance of environmental management.
- Understand and gain knowledge about disaster management

INTERNAL ASSESSMENT:

The internal assessment should be calculated based on the review of the progress of the work done by the student periodically as follows.

Detail of assessment	Period of assessment	Max. Marks
First Review	6 th week	10
Second Review	12 th week	10
Attendance	Entire semester	5
Total		25

EVALUATION FOR BOARD EXAMINATION:

Details of Mark allocation	Max Marks
Marks for Report Preparation, Demo, Viva-voce	65
Marks for answers of 4 questions which is to be set by the external examiner from the given question bank consisting of questions in the following two topics Disaster Management and Environmental Management. Out of four questions two questions to appear from each of the above topics i.e. 2 questions x 2 topics = 4 questions 4 questions x 2 ½ marks = 10 Marks	10
Total	75

DETAILED SYLLABUS

ENVIRONMENTAL & DISASTER MANAGEMENT

1. ENVIRONMENTAL MANAGEMENT

Introduction – Environmental Ethics – Assessment of Socio Economic Impact – Environmental Audit – Mitigation of adverse impact on Environment – Importance of Pollution Control – Types of Industries and Industrial Pollution.

Solid waste management – Characteristics of Industrial wastes – Methods of Collection, transfer and disposal of solid wastes – Converting waste to energy – Hazardous waste management Treatment technologies.

Waste water management – Characteristics of Industrial effluents – Treatment and disposal methods – Pollution of water sources and effects on human health.

Air pollution management – Sources and effects – Dispersion of air pollutants – Air pollution control methods – Air quality management.

Noise pollution management – Effects of noise on people – Noise control methods.

2. DISASTER MANAGEMENT

Introduction – Disasters due to natural calamities such as Earthquake, Rain, Flood, Hurricane, Cyclones etc – Man made Disasters – Crisis due to fires, accidents, strikes etc – Loss of property and life..

Disaster Mitigation measures – Causes for major disasters – Risk Identification – Hazard Zones – Selection of sites for Industries and residential buildings – Minimum distances from Sea – Orientation of Buildings – Stability of Structures – Fire escapes in buildings - Cyclone shelters – Warning systems.

Disaster Management – Preparedness, Response, Recovery – Arrangements to be made in the industries / factories and buildings – Mobilization of Emergency Services - Search and Rescue operations – First Aids – Transportation of affected people – Hospital facilities – Fire fighting arrangements – Communication systems – Restoration of Power supply – Getting assistance of neighbors / Other organizations in Recovery and Rebuilding works – Financial commitments – Compensations to be paid – Insurances – Rehabilitation.

LIST OF QUESTIONS

1. ENVIRONMENTAL MANAGEMENT

1. What is the responsibility of an Engineer-in-charge of an Industry with respect to Public Health?
2. Define Environmental Ethic.
3. How Industries play their role in polluting the environment?
4. What is the necessity of pollution control? What are all the different organizations you know, which deal with pollution control?
5. List out the different types of pollutions caused by a Chemical / Textile / Leather / Automobile / Cement factory.
6. What is meant by Hazardous waste?
7. Define Industrial waste management.
8. Differentiate between garbage, rubbish, refuse and trash based on their composition and source.
9. Explain briefly how the quantity of solid waste generated in an industry could be reduced.
10. What are the objectives of treatments of solid wastes before disposal?
11. What are the different methods of disposal of solid wastes?
12. Explain how the principle of recycling could be applied in the process of waste minimization.

13. Define the term 'Environmental Waste Audit'.
14. List and discuss the factors pertinent to the selection of landfill site.
15. Explain the purpose of daily cover in a sanitary landfill and state the minimum desirable depth of daily cover.
16. Describe any two methods of converting waste into energy.
17. What actions, a local body such as a municipality could take when the agency appointed for collecting and disposing the solid wastes fails to do the work continuously for number of days?
18. Write a note on Characteristics of hazardous waste.
19. What is the difference between municipal and industrial effluent ?
20. List few of the undesirable parameters / pollutants anticipated in the effluents from oil refinery industry / thermal power plants / textile industries / woolen mills / dye industries / electroplating industries / cement plants / leather industries (any two may be asked)
21. Explain briefly the process of Equalization and Neutralization of waste water of varying characteristics discharged from an Industry.
22. Explain briefly the Physical treatments "Sedimentation" and "Floatation" processes in the waste water treatment.
23. Explain briefly when and how chemical / biological treatments are given to the waste water.
24. List the four common advanced waste water treatment processes and the pollutants they remove.
25. Describe refractory organics and the method used to remove them from the effluent.
26. Explain biological nitrification and de-nitrification.
27. Describe the basic approaches to land treatment of Industrial Effluent.
28. Describe the locations for the ultimate disposal of sludge and the treatment steps needed prior to ultimate disposal.
29. List any five Industries, which act as the major sources for Hazardous Air Pollutants.
30. List out the names of any three hazardous air pollutants and their effects on human health.
31. Explain the influence of moisture, temperature and sunlight on the severity of air pollution effects on materials.
32. Differentiate between acute and chronic health effects from Air pollution.
33. Define the term Acid rain and explain how it occurs.
34. Discuss briefly the causes for global warming and its consequences
35. Suggest suitable Air pollution control devices for a few pollutants and sources.
36. Explain how evaporative emissions and exhaust emissions are commonly controlled.
37. What are the harmful elements present in the automobile smokes? How their presence could be controlled?
38. What is the Advantage of Ozone layer in the atmosphere? State few reasons for its destruction.

39. Explain the mechanism by which hearing damage occurs.
40. List any five effects of noise other than hearing damage.
41. Explain why impulsive noise is more dangerous than steady state noise.
42. Explain briefly the Source – Path – Receiver concept of Noise control.
43. Where silencers or mufflers are used ? Explain how they reduce the noise.
44. Describe two techniques to protect the receiver from hearing loss when design / redress for noise control fail.
45. What are the problems faced by the people residing along the side of a railway track and near to an Airport? What provisions could be made in their houses to reduce the problem?

2. DISASTER MANAGEMENT

1. What is meant by Disaster Management? What are the different stages of Disaster management?
2. Differentiate Natural Disasters and Man made Disasters with examples.
3. Describe the necessity of Risk identification and Assessment Surveys while planning a project.
4. What is Disasters recovery and what does it mean to an Industry?
5. What are the factors to be considered while planning the rebuilding works after a major disaster due to flood / cyclone / earthquake? (Any one may be asked)
6. List out the public emergency services available in the state, which could be approached for help during a natural disaster.
7. Specify the role played by an Engineer in the process of Disaster management.
8. What is the cause for Earthquakes? How they are measured? Which parts of India are more vulnerable for frequent earthquakes?
9. What was the cause for the Tsunami 2004 which inflicted heavy loss to life and property along the coast of Tamilnadu ? Specify its epicenter and magnitude.
10. Specify the Earthquake Hazard Zones in which the following towns of Tamilnadu lie: (a) Chennai (b) Nagapattinam (c) Coimbatore (d) Madurai (e) Salem.
11. Which parts of India are experiencing frequent natural calamities such as (a) heavy rain fall (b) huge losses due to floods (c) severe cyclones
12. Define basic wind speed. What will be the peak wind speed in (a) Very high damage risk zone – A, (b) High damage risk zone, (c) Low damage risk zone.
13. Specify the minimum distance from the Sea shore and minimum height above the mean sea level, desirable for the location of buildings.
14. Explain how the topography of the site plays a role in the disasters caused by floods and cyclones.
15. Explain how the shape and orientation of buildings could reduce the damages due to cyclones.

16. What is a cyclone shelter ? When and where it is provided ? What are its requirements ?
17. What Precautionary measures have to be taken by the authorities before opening a dam for discharging the excess water into a canal/river ?
18. What are the causes for fire accidents ? Specify the remedial measures to be taken in buildings to avoid fire accidents.
19. What is a fire escape in multistoried buildings ? What are its requirements ?
20. How the inmates of a multistory building are to be evacuated in the event of a fire/Chemical spill/Toxic Air Situation/ Terrorist attack, (any one may be asked).
21. Describe different fire fighting arrangements to be provided in an Industry.
22. Explain the necessity of disaster warning systems in Industries.
23. Explain how rescue operations have to be carried out in the case of collapse of buildings due to earthquake / blast / Cyclone / flood.
24. What are the necessary steps to be taken to avoid dangerous epidemics after a flood disaster?
25. What relief works that have to be carried out to save the lives of workers when the factory area is suddenly affected by a dangerous gas leak / sudden flooding ?
26. What are the difficulties faced by an Industry when there is a sudden power failure? How such a situation could be managed?
27. What are the difficulties faced by the Management when there is a group clash between the workers? How such a situation could be managed?
28. What will be the problems faced by the management of an Industry when a worker dies because of the failure of a mechanical device due to poor maintenance? How to manage such a situation ?
29. What precautionary measures have to be taken to avoid accidents to labourers in the Industry in a workshop / during handling of dangerous Chemicals / during construction of buildings / during the building maintenance works.
30. Explain the necessity of medical care facilities in an Industry / Project site.
31. Explain the necessity of proper training to the employees of Industries dealing with hazardous products, to act during disasters.
32. What type of disaster is expected in coal mines, cotton mills, Oil refineries, ship yards and gas plants?
33. What is meant by Emergency Plan Rehearsal? What are the advantages of such Rehearsals?
34. What action you will take when your employees could not reach the factory site because of continuous strike by Public Transport workers?
35. What immediate actions you will initiate when the quarters of your factory workers are suddenly flooded due to the breach in a nearby lake / dam, during heavy rain?
36. What steps you will take to avoid a break down when the workers union of your Industry have given a strike notice?
37. List out few possible crisis in an organization caused by its workers? What could be the part of the middle level officials in managing such crisis?

38. What types of warning systems are available to alert the people in the case of predicted disasters, such as floods, cyclone etc.
39. Explain the necessity of Team work in the crisis management in an Industry / Local body.
40. What factors are to be considered while fixing compensation to the workers in the case of severe accidents causing disability / death to them?
41. Explain the legal / financial problems the management has to face if safety measures taken by them are found to be inadequate.
42. Describe the importance of insurance to men and machinery of an Industry dealing with dangerous jobs.
43. What precautions have to be taken while storing explosives in a match/ fire crackers factory?
44. What are the arrangements required for emergency rescue works in the case of Atomic Power Plants?
45. Why residential quarters are not constructed nearer to Atomic Power Plants?

www.binils.com

SANDWICH DIPLOMA COURSE-INDUSTRIAL TRAINING

39291 Industrial Training I (Report writing & Viva Voce)

39292 Industrial Training II (Report writing & Viva Voce)

1. Introduction

The main objective of the sandwich Diploma course is to mould a well rounded technician acclimated with industrial environment while being a student in the institution.

The Sandwich Diploma Course study is pursued by students, in 7 Semesters of 3 ½ years duration, the subjects of 3years-Full Time Diploma Course being regrouped for academic convenience.

While in the 4th semester students under Industrial Training for 6 months(December through May). They also do course work in the institution for one day in a week, While in the 7th semester they undergo another spell of 6 months (June through November) Industrial training.

The Apprenticeship (Amendment) Act 1973 is followed in regulating the Industrial training procedure for Sandwich Course.

I SEM	II SEM	III SEM	IV SEM	V SEM	VI SEM	VII SEM
-------	--------	---------	--------	-------	--------	---------

 Institutional Study

 Industrial Training

2. Attendance Certification

Every month students have to get their attendance certified by industrial supervisor in the prescribed form supplied to them. Students have also to put their signature on the form and submit it to the institution supervisor. Regularity in attendance and submission of report will be duly considered while awarding the Internal Assessment mark.

3. Training Reports

The students have to prepare two types of reports:

- Weekly report in the form of diary to be submitted to the concerned staff in-charge of the institution. This will be reviewed while awarding Internal Assessment marks.
- Comprehensive report at the end of each spell which will be used for Board Examination.

3.1 Industrial Training Diary

Students are required to maintain the record of day-to-day work done. Such record is called Industrial training Diary. Students have to write this report regularly. All days for the week should be accounted for clearly giving attendance particulars (Presence, absence, Leave, Holidays etc). The concern Industrial supervisor is to check periodically these progress reports.

3.2 Comprehensive Training Report

In addition to the diary, students are required to submit a comprehensive report on training with details of the organisation where the training was undergone after attestation by the supervisors. The comprehensive report should be incorporating study of plant/product/process/construction along with intensive in-depth study on any one of the topics such as processes, methods, tooling, construction and equipment, highlighting aspects of quality, productivity and system. The comprehensive report should be completed in the last week of Industrial training. Any data, drawings etc should be incorporated with the consent of the Organisation.

a. Scheme of Evaluation

1.1 Internal Assessment Marks

First Review (during 3 rd month)	: 10 marks
Second Review (during 5 th month)	: 10 marks
Attendance *	: 05 marks (Awarded same as in Theory)
Total	: 25 marks

1.2 Board Examination

Presentation about Industrial Training	: 20 marks
Comprehensive Training Report	: 30 marks
Viva-voce	: 25 marks
Total	: 75 marks

*** For awarding marks to attendance, the Industrial Training attendance has to be considered.**